

**Bioimpedance Analysis to Determine the Effect of Pressure Release on Limb Fluid Volume  
Change in Persons with Transtibial Limb Loss**

Tyler Lee Hartley

A Thesis

submitted in partial fulfillment of the requirements for the degree of

MASTER OF SCIENCE

University of Washington

2012

Committee

Joan Sanders, PhD

Brian Hafner, PhD

Program Authorized to Offer Degree:

Department of Bioengineering

University of Washington

**Abstract**

**Bioimpedance Analysis to Determine the Effect of Pressure Release on Limb Fluid Volume Change in Persons with Transtibial Limb Loss**

by Tyler Lee Hartley

*INTRODUCTION:* Over 1 million Americans currently live with a lower limb amputation. Lower limb prostheses have been designed to produce a secure and comfortable fit between residual limb and prosthesis throughout the day. However, significant fluid volume fluctuations in the residual limb deteriorate socket fit and may cause decreased mobility due to discomfort or soft tissue injury from increased pressures and shear stresses. Extracellular fluid is thought to be the primary source of limb volume fluctuation and commonly decreases over the course of the day. Technologies designed to address limb fluid volume loss are ineffective and cumbersome. Methods to assess limb fluid volume change are also poor, lacking the capability to quantify fluid volume loss at high temporal resolution and while the prosthesis is donned.

*METHODS:* Bioimpedance analysis provides tools to rapidly estimate extracellular fluid volume while a subject performs regular activity with the prosthesis donned. Using a custom bioimpedance analyzer, we tested 16 subjects each on three separate occasions in a repeated measures study. Each

test session consisted of an activity sequence followed by a 30 minute period of calm sitting (dubbed the recovery sit). During the recovery sit, subjects sat with their prosthesis donned (ON), prosthesis doffed (OFF), or liner donned (LINER). An identical activity sequence followed the 30 minute sit.

*RESULTS:* Volume changes during the OFF 30 minute recovery sit were significantly higher than during ON ( $p < 0.001$ ). We observed that after the limb gained fluid volume during the OFF protocol, subsequent volume loss was negligible in 12 of 16 subjects during the following activity sequence. Conversely, volume lost during the 30 minute recovery period during ON was not recovered during three cycles of activity. During the LINER protocol, volume gains during the 30 minute sit were similar to those during OFF, but returned to baseline levels during subsequent activity. Gains in LINER during subsequent activity still remained elevated as compared to ON ( $p < 0.01$ ).

*CONCLUSIONS:* Decreasing applied pressure to the residual limb may function to recover limb fluid volume, allowing socket users to maintain a comfortable fit between limb and prosthesis. There exists a potential for development of socket technology that leverages pressure release to recover limb fluid volume.

# Table of Contents

Table of Figures.....	iii
Acknowledgement .....	iv
<b>1 Introduction and Background .....</b>	<b>1</b>
1.1 Project Overview .....	1
1.2 Review of Residual Limb Volume Change.....	2
1.2.1 Problems associated with limb volume change .....	2
1.2.2 Volume Measurement Technologies.....	3
1.2.3 Technologies to accommodate fluid volume fluctuation .....	6
1.3 Basics of Bioimpedance .....	7
1.3.1 Overview and Previous Applications .....	8
1.3.2 Electrical Properties of Tissue.....	9
1.3.3 Cole Model.....	11
1.4 Summary.....	14
<b>2 Materials and Methods.....</b>	<b>15</b>
2.1 Design and Specifications .....	15
2.1.1 Instrumentation.....	15
2.1.2 Data Collection and Processing.....	20
2.2 Study Design and Procedure.....	22
2.3 Subject Selection.....	24
<b>3 Results .....</b>	<b>25</b>
3.1 Overview.....	25
3.2 Results.....	25
3.2.1 Participant Demographics.....	25
3.2.2 Collected Bioimpedance .....	28
3.2.3 Recovery Period Fluid Volume Change.....	29
3.2.4 Effect of Recovery Period on Fluid Volume During Activity .....	30
3.2.5 Subject and Demographic Analysis.....	32
3.3 Conclusion.....	34
<b>4 Discussion .....</b>	<b>35</b>
4.1 Physiological Investigation and Hypothesis.....	36

4.2	Effects of a Prosthetic Liner .....	41
4.3	Variation between Anterior and Posterior Measurements.....	44
4.4	Parameter Analysis .....	51
<b>5</b>	<b>Future Work .....</b>	<b>54</b>
	<b>List of References.....</b>	<b>56</b>

## Table of Figures

Figure 1.1 (Grimnes and Martinsen 2006): The three most common types of bioimpedance electrode configurations.....	9
Figure 1.2 (De Lorenzo et al. 1997): Expected current path through human tissue at both low and high frequencies .....	10
Figure 1.3: (De Lorenzo et al. 1997): Cole model circuit with representative electrical components..	11
Figure 1.4: (De Lorenzo et al. 1997): The Cole plot and components .....	12
Figure 2.1: T of the construction of a sensing electrode .....	17
Figure 2.2: Diagram of electrode placement on the residual limb.....	19
Figure 2.3: Image of electrode placement and routing.....	20
Figure 3.1: Sample data collected during OFF test for one subject.....	28
Figure 3.2: Average change in volume across all subjects for each protocol.....	31
Figure 3.3: Long-Term and Short-Term Volume Change for each of the three protocols, presented on a subject-by-subject basis.....	33
Figure 4.1: Comparison of $\Delta_{pre}$ and $\Delta_{post}$ for both ON and OFF tests.....	39
Figure 4.2: Volume change over the course of a day and volume “target range” .....	40
Figure 4.3: Volume change during the 30 minute recovery period at sit.....	44
Figure 4.4: A comparison of volume change during LINER test for whole anterior and whole posterior measurements. ....	46
Figure 4.5: Change in volume during the LINER test 30 minute recovery period for anterior and posterior. ....	47
Figure 4.6: Artist’s depiction of a residual limb with high tibial prominence .....	49
Figure 4.7: Anterior and posterior regions of the transtibial limb .....	51

## Acknowledgement

The author wishes to recognize the effort and hard work put forward by Sanders Lab members who made data collection possible, and express appreciation for the patience and guidance Joan Sanders provided throughout the learning process. Thanks to Reid Phillips for being a springboard for ideas, and for working out a few too many Indigo bugs. Recruiting human subjects and scheduling lab sessions would not have been possible without tireless efforts from Kate Allyn and Dan Harrison. Thanks to friends and roommates who have made Seattle a genuine joy. Thanks also to my family for being continually present and ready with advice. And of course, thanks to Jennifer Lundstrem for being everything else.

# 1 Introduction and Background

## 1.1 Project Overview

Over 1 million Americans currently live with lower limb amputations (Ziegler-Graham et al. 2008). The vast majority of these amputations are due to vascular disease, often as a result of diabetes. As Type II diabetes becomes more prevalent in the American population, so too does the rate of lower-limb amputation. Military conflicts and wars abroad have also increased the numbers of amputees, and have increased public awareness of Americans living with amputation (Owings and Kozak 1998; Fox et al. 2005). As population and awareness have grown in recent years, effective, user-friendly prosthetic technologies have become priority engineering challenges.

Lower limb prostheses require a secure and comfortable fit between the prosthetic socket and residual limb to provide an effective coupling between the prosthesis and the user. In an ideal scenario, successful and accurate agreement between limb and socket effectively transfers force and distributes pressure and weight-bearing while minimizing shear stress on the skin (Hachisuka et al, 1998; Sonck et al, 1970). However, during daily use, significant fluid volume fluctuations of the residual limb affect the fit of the prosthetic socket. These volume changes prompt the addition or subtraction of socks, decreased activity level due to discomfort, and/or risk of soft tissue injury from increased pressures and shear stresses. Fluid content of the body consists of extracellular fluid (ECF) and intracellular fluid (ICF). ECF primarily consists of blood and interstitial fluids while ICF consists of fluid volume contained within cells themselves. ECF volume is the primary source of limb volume fluctuation in the residual limb (Zachariah et al. 2004).



Amputees commonly lose volume during the course of the day, and do not regain. Fluid volume loss in the limb has been identified as perhaps the leading problem facing modern prosthetic technology today (Backus 2005). Loss of volume can take place over the course of minutes, hours, or an entire day. Fluid loss is likely due to pressure exerted on the limb by the socket, thus forcing fluid out of the interstitium and evacuating blood from the vascular system. Therefore, it may be possible to induce a long-lasting volume recovery simply by reducing the external force generated by a prosthesis. We aim to better understand the large-scale effect of pressure relief on residual limb volume.

## **1.2 Review of Residual Limb Volume Change**

### **1.2.1 Problems associated with limb volume change**

Prior research has demonstrated a variety of clinical problems associated with limb volume loss. Decreases in limb fluid volume can lead to pain or localized pressures (Board, Street, and Caspers 2001), increased movement of the stump within the socket (i.e. pistoning) (Grevsten and Eriksson 1974; Grevsten 1978; Commean et al. 1996; Commean and Smith 1997), increase shear stress and pressures (Sanders, Daly, and Burgess 1992; Sonck, Cockrell, and Koepke 1970; Silver-Thorn, Steege, and Childress 1996; Hachisuka et al. 1998) and diminished sensation of proprioception or contact between limb and socket (Sabolich and Ortega 1994; Dingwell, Davis, and Frazier 1996).

Currently, no technologies accurately and reliably accommodate for limb fluid volume loss within the prosthesis. We propose that it may be possible to recover lost volume by temporarily relieving external pressure applied by the socket. Relief of socket pressure may then decrease interstitial pressure in the limb, returning blood to the vascular system and creating a negative pressure gradient from the vasculature into the extracellular space. This would then encourage natural fluid transport of ECF into the interstitium and decreases fluid transport out of the interstitium (Zachariah et al. 2004). With fluid volume returned to the residual limb, agreeable fit between limb and

prosthesis will be regained while pain and difficulty of prosthetic use will be avoided. Consequently, there exists the potential for innovative prosthetic technology to leverage this property by designing sockets to release pressure during periods of non-ambulation, thereby preventing sustained limb volume loss and ensuring a continual fit throughout the day.

### **1.2.2 Volume Measurement Technologies**

Knowledge of how limbs change over time requires accurate characterization of volume. A number of methods have been developed to describe residual limb volume change (Sanders and Fatone 2011). One of the earliest and most direct methods is through simple anthropometric measurements. Limb circumferences or diameters can be measured at discrete points along the length of the residual limb using a tape measure or calipers. When recorded, these measurements can be used as a relative measurement of long-term limb volume change (Golbranson et al. 1988; Boonhong and Manathip 2004; Boonhong 2006). However, such measurements have also been shown to exhibit error. Boonhong et al. compared anthropometric measurements to volume measured by water displacement, and found that anthropometric techniques reliably overestimated volume by 4% (Boonhong 2006). Thus, while volume assessment by anthropometric techniques may be successful at identifying macroscopic changes in limb volume, it is unable to describe short-term fluctuations and has dramatically lower spatial resolution compared to other techniques (Boonhong 2006).

Water displacement provides an alternative measurement method that shows increased accuracy of volume measurements, and allows for determination of segmental volumes. To measure volume with this method, the residual limb is lowered into a tank of water. Displaced water outflows and is captured for measurement. The displaced volume of water is then taken to be the volume of the limb. Water displacement has the advantage of being straightforward and simple to implement.

However, slight motion of the residual limb and water tension at the interface of skin and water reduce the absolute accuracy of the method (Fernie, Holliday, and Lobb 1978; Starr 1980).

Laser scanning allows limb shape to be determined from the reflection of high-intensity light off the residual limb. A laser device projects a plane of light onto the residual limb. The resulting shape of this plane projected on the limb is captured on video. The shape and contour of the projection is then computed to form a three-dimensional model of the residual limb. When projected perpendicularly to the limb, laser scanning can provide accurate estimations of shape and volume with high resolution (Lilja and Oberg 1995; Johansson and Oberg 1998). However, current laser scanners require the subject to remain motionless for the duration of the scan for as little as 10 seconds, although most require much longer. Although volume measurements obtained with laser scanning were reported to be highly repeatable, laser scanning still suffers from relatively low temporal resolution compared to other technology. Further, laser scanning is hindered by the requirement for the limb to be motionless and located outside of the socket during scan.

Optical scan technology works in much the same way as laser scanning, instead imaging the outside contour of the limb against a high-contrast background and identifying the edge of the limb in post-processing. A series of images can subsequently be computed into a three-dimensional shape, given a sufficient number of images from varying angles. Optical scanning can be performed more rapidly than laser scanning, and can also produce similarly high spatial resolution (Zachariah et al. 2004; Commean, Smith, and Vannier 1996). However, optical scans suffer from many of the same limitations as laser scans, namely, relatively low temporal resolution, the requirement for a motionless residual limb, and the removal of the prosthesis.

Magnetic Resonance Imaging (MRI) is well established as a method for imaging internal body structures with high spatial resolution. MRI uses a powerful magnet to rapidly alter the alignment of

atomic nuclei within the human body. This causes nuclei to generate a detectable magnetic field which is captured by the MRI scanner, and later computed to form a cross-sectional image of the body. When MRI collects discrete cross-sectional slices of the residual limb, both volume and external contour can be measured with great accuracy (Pettersen and Høgetveit 2011). MRI has been used to measure residual limb volume (Buis et al. 2006) but use of this technology for such purposes is uncommon due to the large temporal resolution for image capture (~10 minutes). While it is possible to image the limb inside of the prosthesis, the subject must remain motionless during the entirety of image capture (Portnoy et al. 2009).

Ultrasound is additionally capable of generating a 3-D cross-sectional image of the residual limb, but at a much lower resolution than MRI. The limb is placed in a water tank and stabilized. A B-scanning ultrasound device is mounted and rotated around the limb, scanning through the water tank (He, Xue, and Murka 1997; Singh, Hunter, and Philip 2007). To generate a complete image may take up to 13 minutes, rendering the technology incapable of capturing short-term volume changes and sensitive to limb motion (He et al. 1996). Similar to previous technology, ultrasound imaging of the residual limb is hindered by the requirement for the limb to be motionless and located outside of the socket during scan.

Bioimpedance allows the estimation of limb fluid volume by sensing resistance to electrical flow in the tissue of interest. Current is injected into tissue using skin-surface electrodes, while impedance to flow is sensed using additional electrodes placed over the tissue of interest. Impedance values are then converted into extracellular or intracellular fluid volume using bioelectrical calculations (De Lorenzo et al. 1997). Because the system of measurement is fixed on the residual limb and consists of low profile electrodes and wires, bioimpedance can be used to measure fluid volume inside the socket and during ambulation, unlike any of the previous technologies that require a stationary,

exposed limb (Sanders et al. 2009). In contrast to other volume estimation methods, bioimpedance can also be performed at high temporal resolution with the residual limb within or out of the socket.

### **1.2.3 Technologies to accommodate fluid volume fluctuation**

Prosthetic socks are commonly used to control prosthetic fit. Socks are woven sleeves worn either between the limb and socket or between the liner and socket. Sock number and thickness (i.e. ply) may be adjusted throughout the day to accommodate for fluid volume change (Sanders, Cagle, Harrison, et al. 2012). While prosthetic socks are worn by a large number of amputees, they are not an ideal solution to address fluid volume loss as they often are not properly changed or adjusted and are inconvenient to apply.

Vacuum-assisted suspension sockets have also been employed to indirectly control limb fluid volume. A vacuum-assisted socket applies negative pressure to the distal end of the limb, facilitating volume increase (Beil, Street, and Covey). Vacuum-assisted sockets often employ a one-way valve, actuated by the pressure of the limb during weight bearing in a slightly undersized socket (Chino et al. 1975). One-way valve, passive sockets are often referred to as suction sockets. Vacuum can also be attained via a mechanically or electrically powered vacuum device integrated into the prosthesis which is subsequently controlled by the user (Board, Street, and Caspers 2001; Goswami et al. 2003). In practice however, determining and controlling vacuum level is difficult. Vacuum is easily lost due to improper sealing of the limb within the prosthesis and even if maintained can be insufficient to produce sufficient suspension or can produce pain and irritation of the limb (Goswami et al. 2003).

Inflatable inserts provide another means for socket volume control. These inserts are often filled with air or incompressible liquid. However, air filled bladders can only account for small changes in volume. Fluid filled inserts address this limitation and were used in several research studies (Greenwald and Dean 2003; Sanders and Cassisi 2001) but investigators identified issues in reliably

determining necessary fluid volume of the bladder system. Furthermore, Sanders et al. found that as bladder volumes were increased, fluid was ejected from the limb and upon reduction of bladder size, limb volume did not easily return.

Modern technologies designed to address limb volume change, like woven socks, vacuum sockets, or inflatable inserts, are ineffective (Sanders and Fatone 2011). To make matters worse, tools used to quantify and track limb fluid volume change lack the temporal resolution, portability, and accuracy necessary to fully understand when and how limb volume changes. We propose the use of bioimpedance analysis to measure limb fluid volume change and address this gap in knowledge. Bioimpedance is capable of capturing rapid changes in fluid volume and is able to make these measurements while the limb is within or out of a prosthesis (Sanders, Rogers, and Abrahamson 2007). Given this flexibility in fluid volume calculation, we investigate socket doffing as a potential therapy for fluid volume loss.

### **1.3 Basics of Bioimpedance**

Bioimpedance is a non-invasive technique capable of estimating the fluid volume of tissue by injecting and sensing small amounts of electrical current. The most basic embodiment of a bioimpedance system requires two conductive electrodes placed on the skin. Each electrode injects a current at a specified frequency or series of frequencies. Simultaneously, both electrodes sense the complex impedance to flow of injected current, calculated as a transfer impedance between the electrode pair. This dipolar system allows an estimation of total body water (TBW) (Hoffer, Meador, and Simpson 1969). When current is injected across a range of frequencies (called bioimpedance spectroscopy), it is additionally possible to estimate total body water ECF and ICF from the calculated impedances (Sanders, Rogers, and Abrahamson 2007; Sanders et al. 2009).

### 1.3.1 Overview and Previous Applications

Bioimpedance spectroscopy has previously been employed in a variety of medical applications. Most commonly, *whole body impedance* is used for the estimation of TBW, total body extracellular fluid, or total body intracellular fluid. In this configuration, electrodes are attached at the wrist and ankle. Sensed impedance is thus assumed to reflect the overall impedance of the entire body, and using specific anatomical calculations, TBW can be estimated (Hoffer, Meador, and Simpson 1969; Segal and Burastero 1991; Wotton et al. 2000). Because fat has a lower admittivity than does muscle and other tissue, it is additionally possible to estimate body fat percentage. In general, when applied to the body as a whole the intention is usually to characterize TBW, the ratio of ECF/ICF, and fat mass. Bioimpedance is also employed in skin hydration estimation, which is essential for proper function and appearance of the skin (Martinsen, Grimnes, and Haug 1999).

*Segmental bioimpedance* functions much in the same way as whole-body impedance. Electrodes are carefully placed on segments of interest, for instance the thorax or the thigh. This allows the estimation of specific tissue segments, instead of the whole body.

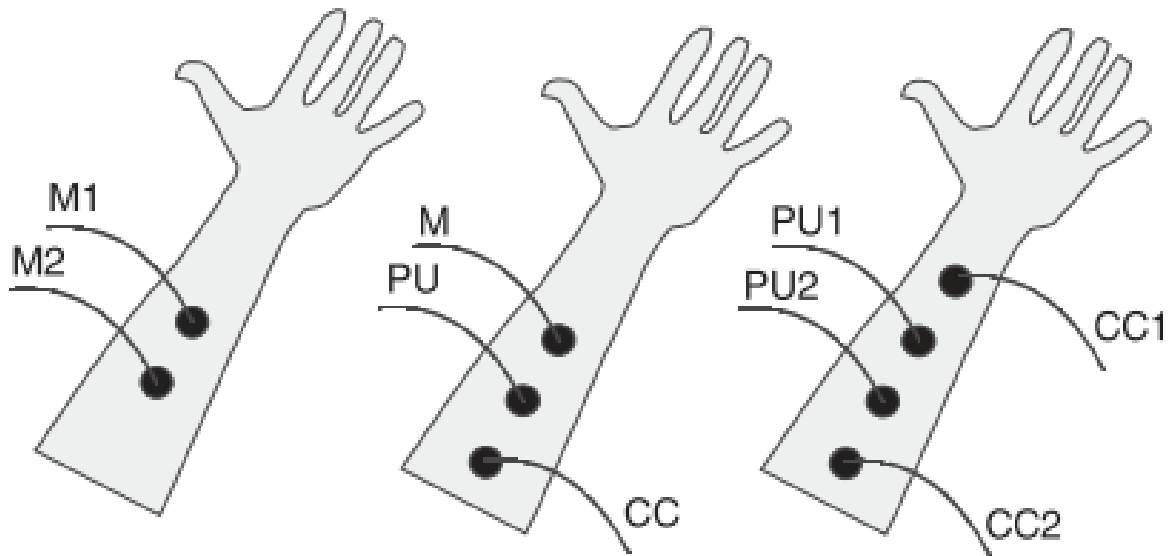

**Figure 1.1** (Grimnes and Martinsen 2006): **The three most common types of bioimpedance electrode configurations.** (M = Mixed, CC = current carrying, PU = pickup (sensing) electrode). At left, a bipolar system where both injecting electrode and sensing electrodes are shared. In middle, a tetrapolar system with one injector separated from a sensing electrode. At right, a tetrapolar system, which separates sensing electrodes from current injecting electrodes entirely.

One of the most accepted bioimpedance configurations is the tetrapolar. Consisting of four electrodes instead of two, a tetrapolar system allows the separation of current injecting and current sensing components Figure 1.1. A tetrapolar arrangement provides a distinct advantage over bipolar or tripolar systems by avoiding the electrical polarization of sensing electrodes often biasing the sensed value of impedance (Martinsen and Grimnes 2008; Grimnes, Martinsen, and Johnsen 2010). Furthermore, by placing sensing electrodes at a distance from the injecting electrodes, a more uniform current density may be assumed at the site of measurement (Grimnes and Martinsen 2006).

### 1.3.2 Electrical Properties of Tissue

Bioimpedance is based on the ability to measure resistance to electrical current passing through human tissue. Different components of the human body – skin, muscle, bone, fascia, blood – differentially contribute to bioimpedance based on their electrical properties. Bone and superficial fascia are considered to be non-conductive (Kosterich and Foster 1983), thus sensed impedance is primarily attributed to muscle, fat, blood plasma, and skin.



The two main components thought to contribute to sensed impedance in human tissue are intracellular fluid (ICF) and extracellular fluid (ECF) volume. ICF consists of the water and other liquids contained within cell walls (Leaf 1970). ECF consists of any interstitial fluid, blood plasma, and transcellular fluid. Research has shown that extracellular fluid contributes the vast majority of electrical impedance at low frequencies (<50kHz). At these frequencies, cell membranes act as a capacitor, preventing ICF from contributing to overall sensed impedance (Segal and Burastero 1991). However, at higher frequencies (>200kHz) current is conducted through both ICF and ECF, causing a decrease in overall resistance to electrical flow compared to lower frequencies (Figure 1.2) (Jenin et al. 1975; Baumgartner, Chumlea, and Roche 1990).

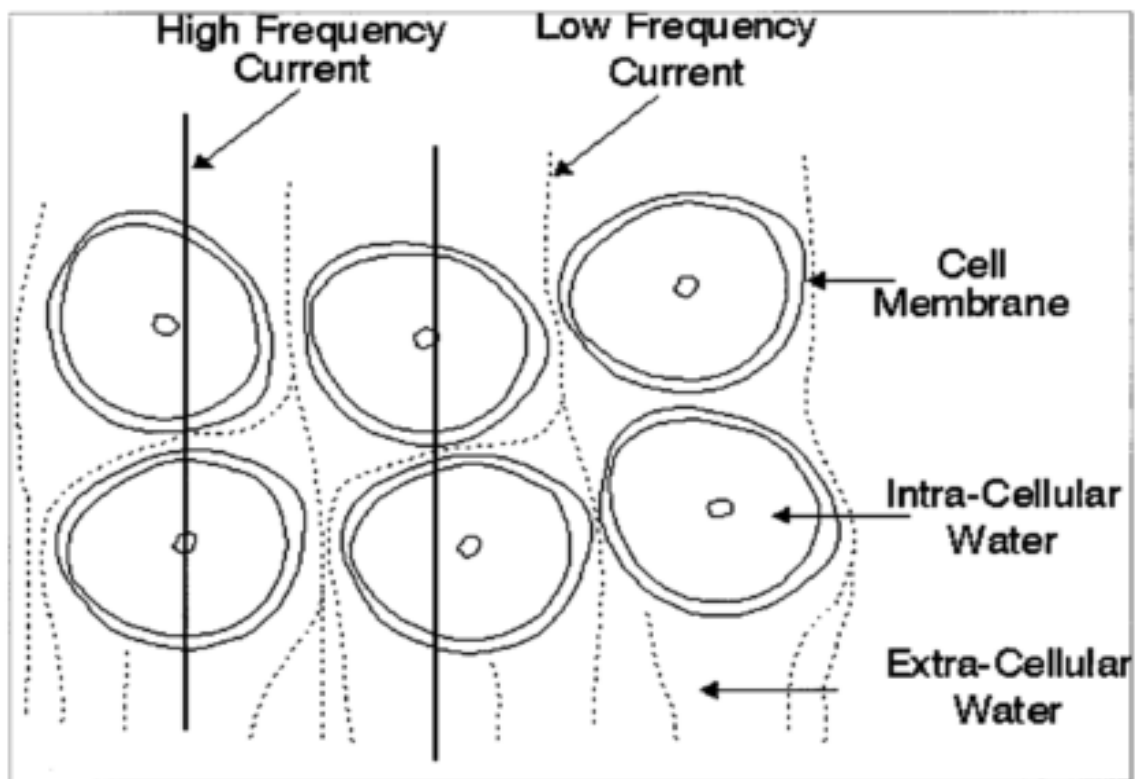

**Figure 1.2 (De Lorenzo et al. 1997): Demonstration of the expected current path through human tissue at both low and high frequencies. Low frequencies travel primarily through ECF while high frequencies penetrate cells capturing ICF.**

The difference in electrical conductivity between low and high frequencies is due, in large part, to the capacitive effect of cellular membranes (Schwan 1957). As direct current cannot pass through a capacitor in the low frequency range, electricity conducts minimally through cells. Thus, overall conductivity is primarily due to ECF. However, cell membranes rapidly charge and discharge at the rate of the alternating current as frequency increases, decreasing the effect of membrane capacitance and allowing current to pass.

### 1.3.3 Cole Model

In 1969, Kenneth Cole developed a mathematical expression to relate complex impedance measured over a range of frequencies to both intracellular and extracellular resistance (K.S. Cole, Li, and Bak 1969; K. S. Cole 1940). Cole demonstrated that human tissue can be approximated by a resistor and capacitor in parallel with a single resistor (Figure 1.3).

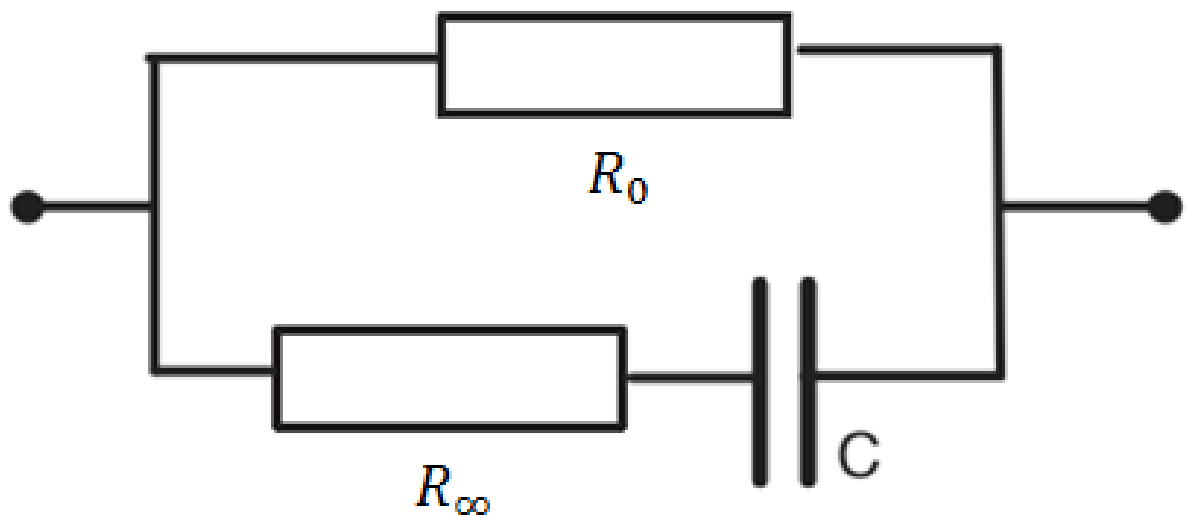

Figure 1.3: Cole model circuit with representative electrical components. (De Lorenzo et al. 1997)

The complex impedance of this circuit is then given by the generalized Cole<sub>z</sub> equation, developed by Cole in 1940

$$Z = R_{\infty} + \frac{R_0 - R_{\infty}}{1 + (j\omega\tau_Z)^\alpha} \quad (1)$$

where  $Z$  is the complex impedance of the circuit,  $R_{\infty}$  represents resistance at infinitely high frequencies, and  $R_0$  represents resistance at very low frequencies.  $\tau_Z$  is the characteristic time constant of the system. As previously discussed, at very low frequencies ECF contributes the vast majority of sensed impedance ( $R_0$ ). At very high frequencies ICF is responsible ( $R_{\infty}$ ). Therefore,  $R_0$  and  $R_{\infty}$  can be thought of as  $R_{ECF}$  and  $R_{ICF}$ .

When complex impedance is gathered over a range of frequencies and plotted on a resistance-reactance graph, a characteristic curve is generated Figure 1.4. This plot is referred to as the impedance locus, and its shape is a characteristic result of electrical tissue properties (Kenneth Stewart Cole 1968). The intersection of the impedance locus with the resistance axis represents the value of impedance for the ideal resistors  $R_0$  and  $R_{\infty}$ . By estimating these two intersection points,  $R_{ECF}$  and  $R_{ICF}$  can be calculated.

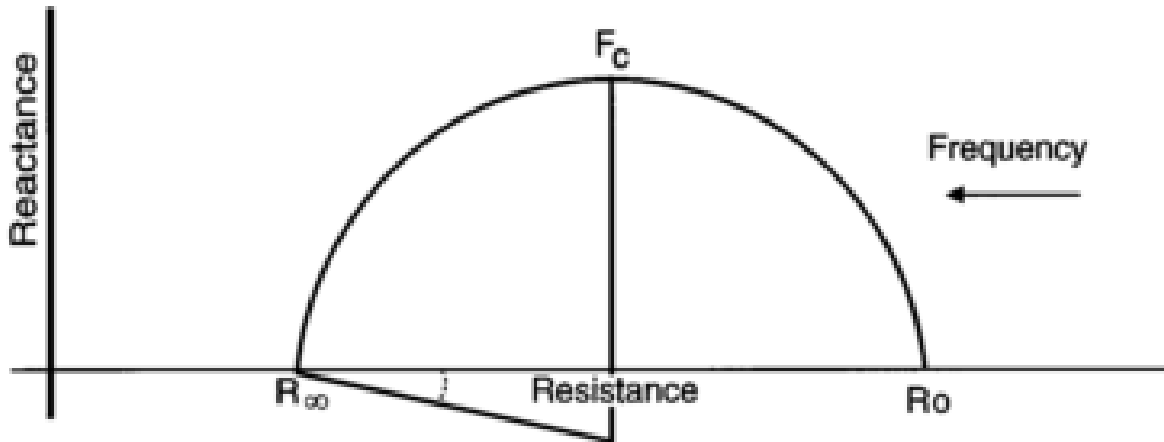

Figure 1.4: The Cole plot, also referred to as an impedance locus. The intersection points with the x axis correspond to estimated values of  $R_0$  and  $R_{\infty}$ . (De Lorenzo et al. 1997)

Hanai et al. furthered Cole's equation by introducing mixture theory into bioimpedance. Hanai's mixture theory accounts for a conductive solution containing suspended nonconductive spheres, much like human tissue containing nonconductive cells (Hanai 1968). By incorporating Hanai's theory, we are able to account for nonconductive cell membranes suspended in highly conductive ECF when estimating impedance at low frequencies. Equation 2 describes the relationship between  $R_{ECF}$ ,  $R_{ICF}$ ,  $C_m$  (the membrane capacitance of cells) and  $Z_{observed}$ , (observed complex impedance) when accounting for mixture theory.

$$Z_{obs} = \left( \frac{R_e}{R_e + R_i} \right) \left( R_i + \frac{R_e}{1 + [j\omega C_m (R_e + R_i)]^\alpha} \right) \quad (2)$$

The exponential parameter  $\alpha$  is analogous to a phase angle of the electrical system. Grimnes describes  $\alpha$  as a flexible, widely applied variable that may correspond to "a) different degrees of molecular interaction, b) cellular interactions and properties of gap junctions, c) anisotropy, d) cell size, or e) fractal dimensions." (Grimnes and Martinsen 2006, p223), but is still considered an invariant material property in the same manner of resistivity. The  $\alpha$  parameter can vary between 0 and 1 – a value of zero corresponds to a purely resistive case, while a value of one corresponds to a no loss case of ideal resistors and capacitors.

De Lorenzo et al. implemented a further correction to the Cole model to account for  $\alpha$  frequency invariant time delay, dubbed  $T_d$  (De Lorenzo et al. 1997; Matthie et al. 1992).  $T_d$  arises due to the difference in speed by which an electrical signal conducts through a conductor, as compared to other electrical components.  $T_d$  is correlated with conductor length (i.e. copper wire length), stray capacitance, or transmission line effects.  $T_d$  can account for the sum total error generated by these components, and causes a linear shift in phase error as frequency increases, meaning it can be accounted for with a simple addendum to equation 1:

$$Z_{obs} = \left( \frac{R_e}{R_e + R_i} \right) \left( R_i + \frac{R_e}{1 + [j\omega C_m (R_e + R_i)]^\alpha} \right) (e^{-j\omega T_d}) \quad (3)$$

In practice, iterative nonlinear curve-fitting software is required to optimize and estimate  $R_{ECF}$ ,  $R_{ICF}$ , and  $C_m$  given values for given  $Z_{observed}$ ,  $T_d$ , and  $\alpha$ .

## 1.4 Summary

Residual limb fluid volume loss is a commonly experienced problem for persons with transtibial limb loss. The loss of fluid volume can adversely affect the fit of a prosthesis, causing pain at the site of bony protuberances, allowing the limb to move within the socket, and increasing shear stress and associated pain. While many technologies exist to control limb volume, none are effective at adapting to limb volume changes. Attempts to quantify volume change in the residual limb have also met challenges. Most technologies used to measure limb volume change lack the necessary temporal resolution to capture rapid volume change, require subjects to maintain a stationary posture, or cannot estimate volume change while the socket is donned. Bioimpedance allows a continuous, rapid estimation of limb volume while a socket user performs ordinary activities. Utilizing bioimpedance, we attempted to investigate the efficacy of a potential technique to return fluid volume to the residual limb and to measure this change using a suitable technology. As wearing a prosthesis decreases limb fluid volume throughout the day, we hypothesized that relief of applied pressure may induce fluid volume recovery and that we could use bioimpedance to characterize fluid volume change induced by this release. Thus, we have two aims for this study.

The first aim is to quantify the amount of change in limb fluid volume when socket pressure is released, since we expect limb fluid volume to increase under decreased pressures. The second aim is to determine the amount of volume gained during pressure release that is maintained throughout subsequent activity with the socket donned and pressure returned.

## 2 Materials and Methods

### 2.1 Design and Specifications

To measure limb fluid volume, a customized bioimpedance system was designed and built. Dubbed the Indigo, it was intended to produce higher temporal resolution and collect multiple simultaneous measurements as compared to preexisting bioimpedance technology. The Xitron device (Hydra 4200, Xitron, San Diego CA) was a single channel tetrapolar bioimpedance analyzer previously used by Sanders lab for fluid volume estimation. The Indigo was built to surpass the Xitron's technical specifications and to provide four independent tetrapolar measurements of impedance while maintaining one shared current injection pair. Four channels allow four simultaneous measurements of impedance from separate locations on the limb.

#### 2.1.1 Instrumentation

The Indigo system has four independent sensing channels and one current injecting channel. The sensing channels are tetrapolar systems, whereby the current injecting electrodes are separated from the sensing electrodes. Both the current injection and current sensing channels consist of two leads, one positive and one negative. Impedance is thus reported as a transfer impedance between each pair of leads. A tetrapolar system has a distinct advantage over bi and tripolar systems due to its ability to largely reduce the influence of electrode polarization impedance (Grimnes 2007). By separating current injecting and sensing electrodes, the impedance of sensing leads is decreased dramatically and is not dependent on the injected current profile. Nevertheless, Grimnes et al. states that tetrapolar systems may demonstrate sensitivity to volumes closer to the electrode (Martinsen, Grimnes, and Haug 1999; Grimnes and Martinsen 2006) and thus it is important that electrode properties and locations are carefully selected.

The Indigo is capable of producing a variety of current profiles. The number of frequencies applied, the length of time each frequency is applied, and the amplitude of the signal itself are all programmable. For the study, we selected a current profile injecting across 30 frequencies, yielding a sampling rate of  $\sim 24$  Hz and producing  $\sim 300$   $\mu\text{A}$  output. We chose a total of 30 frequencies to provide sufficient resolution across the frequency spectrum from 5kHz to 1MHz. The Indigo is capable of producing a  $\sim 300$   $\mu\text{A}$  maximum output current (see section 2.1.2 for further information). The Indigo device was placed on a portable battery powered cart to provide mobility and to separate the circuitry of the Indigo system from wall electrical circuit. The Indigo was initially designed to function off of AC wall power. The Indigo was electrically isolated from wall power on a battery powered cart. Electrical independence ensures safety to the user in the case of a sudden electrical surge in the building circuitry. Wires representing each of the 10 channels (eight current sensing, two current injecting) were constructed to be 1.2 meters long. These wires terminated in soldered gold pin connectors which were in turn attached to adhesive, conductive, hydrogel electrodes to be placed on the residual limb.

An electrode design was chosen and validated after extensive review of available electrode designs. Electrodes were composed of hydrogel (Katecho KM-10B hydrogel) backed with conductive tape (ARcare conductive adhesive) to encourage even conduction. Gold wire terminals were placed between the conductive tape and hydrogel and secured in place with additional short strips of ARcare (Figure 2.1). Reference electrodes were 1.5 cm by 5 cm in size. Proximal thigh current injection electrodes were 1.5 by 15 cm while the distal injection electrode was a circle of 3cm diameter. Before the placement of electrodes, skin was prepared with sandpaper (Red Dot Trace Prep 2236, 3M) and a couplant (Couplant D, GE Panametrics) was applied to each electrode before application to encourage electrical signal transmission.

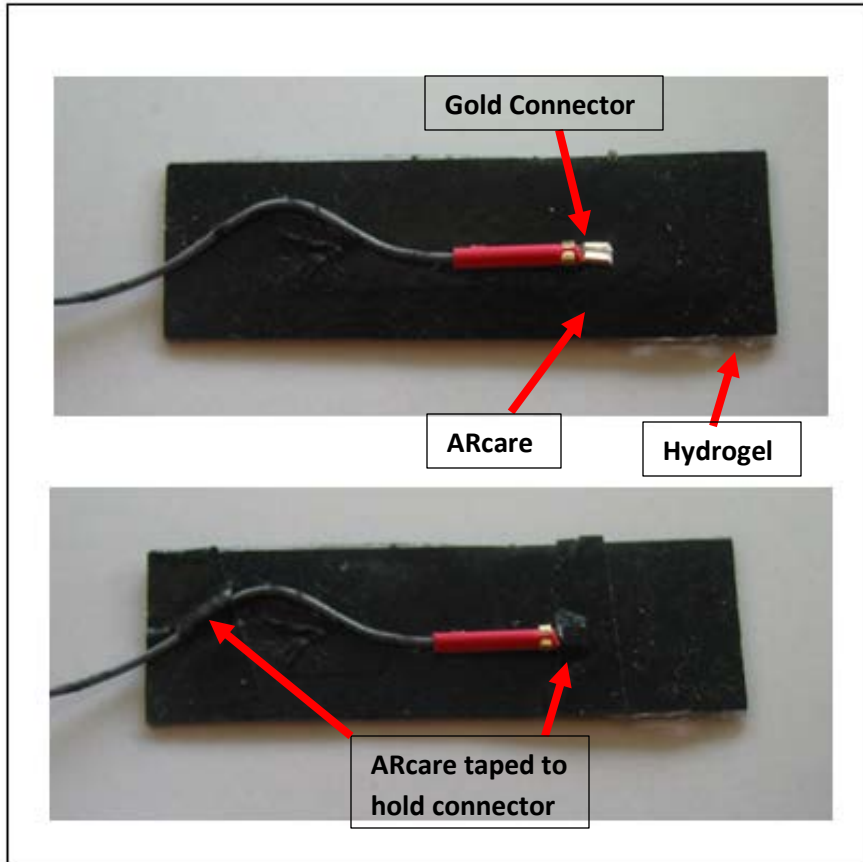

**Figure 2.1: Top view of the construction of a sensing electrode. Process was identical for injection electrodes, using different dimension hydrogel and conductive tape.**

Placement of the injecting and sensing electrodes was paramount to minimizing artifacts and errors of the tetrapolar system. Bony protuberances were avoided to minimize stresses on the electrodes, and locations at least 3 cm away from the distal current injection electrode were selected to ensure homogeneous current density (Sanders, Rogers, and Abrahamson 2007). Two independent sensing channels were placed on the anterior portion of the limb and two were placed on the posterior. One of the anterior channels sensed along the entire length of the antereolateral residual limb with one electrode placed just laterally to the terminus of the patellar tendon. The second electrode was placed lateral to the distal tip of the tibia, where tibial beveling was felt to occur. These two electrodes comprised channel 2 (Ch2). The second anterior channel shared the proximal electrode with the first anterior channel, just lateral to the patellar tendon. The second electrode for the



second channel was placed halfway between the end of the patellar tendon and the end of the tibia thus comprising channel 1 (Ch1). A diagram of the electrode scheme is shown in Figure 2.2. The two remaining channels were placed in a similar fashion along the midline of the posterior limb. Channel 4 (Ch4) sensed the entirety of the posterior. Both electrodes for this channel were placed opposite the electrodes from Ch2. Channel 3 (Ch3) shared a proximal electrode with Ch4. The second electrode of Ch3 was placed halfway in between the two sensing channels of Ch4 (Figure 2.2). Wires extending from the electrodes were routed into strain-relief loops using 3M Tegaderm as the adhesive, shown in Figure 2.3. Great care was taken to reproduce these electrode placements in subsequent tests by referring to photographs of the limb and recording distances between the sensing electrodes of each channel.

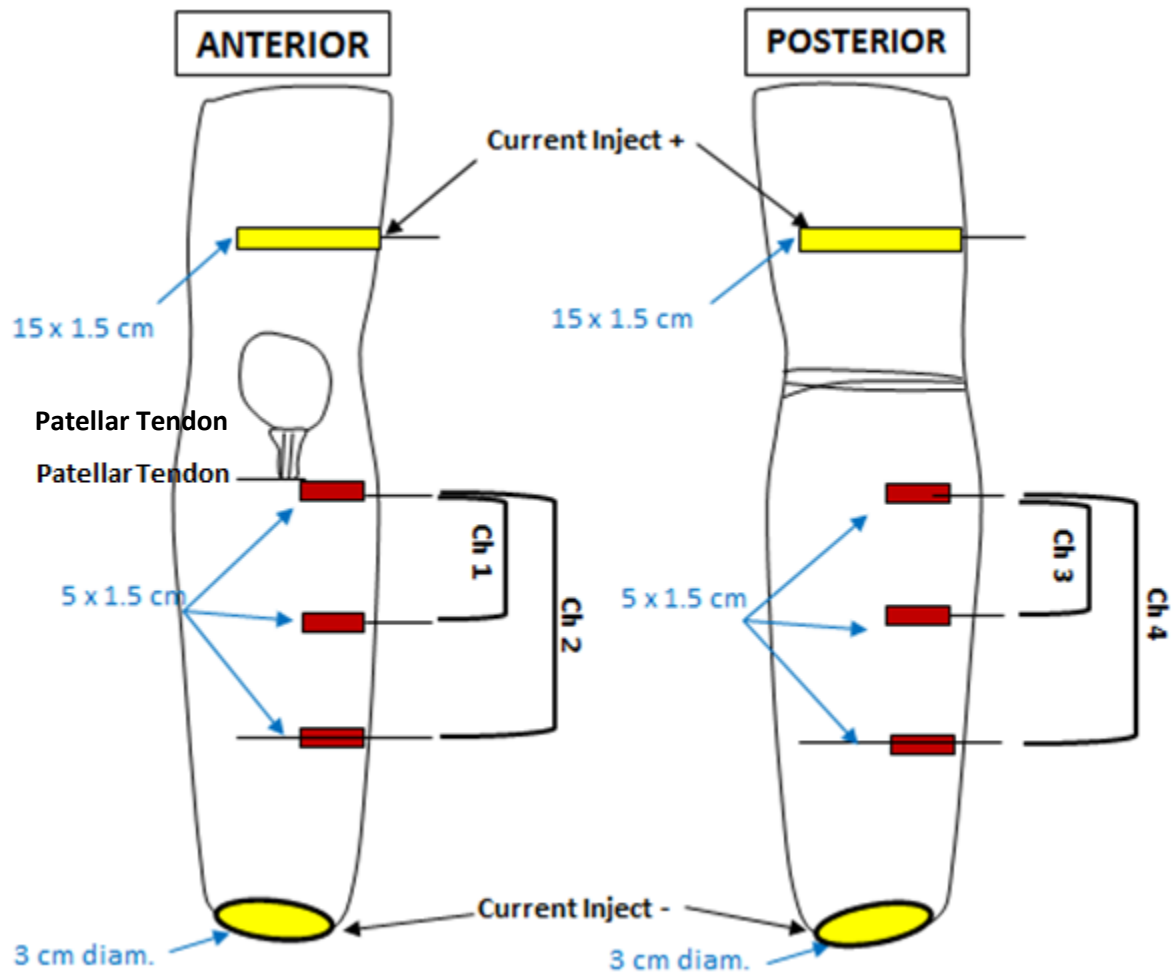
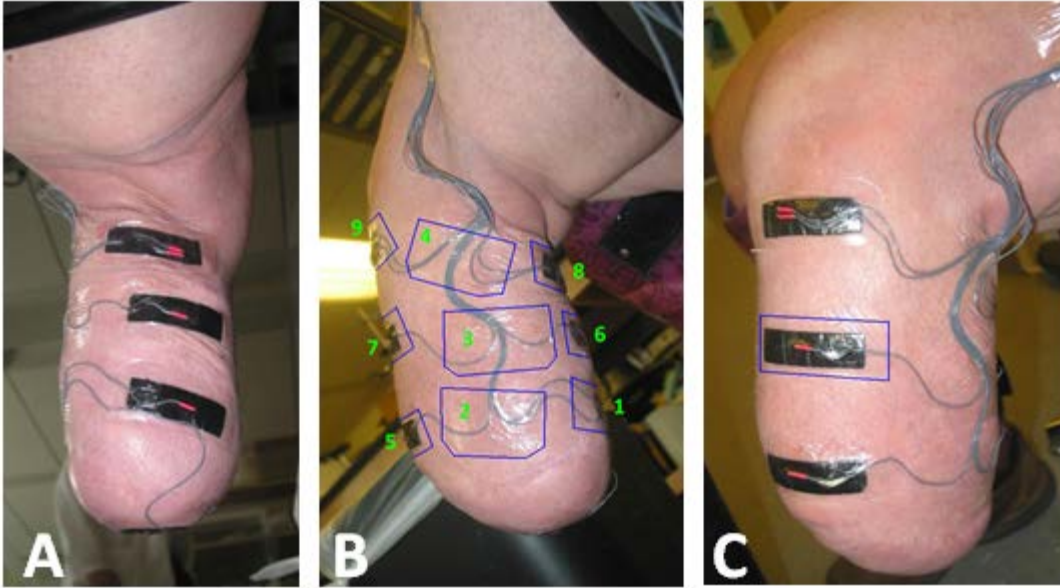

Figure 2.2: Diagram of electrode placement on the residual limb. Note that two positive current injectors were used (anterior and posterior of limb) with one circular distal negative current injector.



**Figure 2.3: A - Posterior electrode placement. B – Wire routing on the medial aspect of the limb. C – Anterior electrode placement.**

Though four independent measurements of volume were made during each test, analysis of fluid volume change in this thesis focuses primarily on the volume measured from the whole posterior compartment (Ch4 in Figure 2.2). The posterior region accounts for the majority of ECF volume and is the location that would be primarily targeted for a socket release device, due to the relatively high amount of soft tissue in this location. All results discussed below are thus taken from analysis of data collected by electrodes placed on the posterior section of the limb, unless otherwise noted.

### **2.1.2 Data Collection and Processing**

To ensure sufficient resolution across the impedance locus, impedance was collected at 30 frequencies logarithmically spaced between 5kHz and 1MHz, generally accepted to be the range of interest necessary to characterize intra and extracellular resistance (Zhu et al. 2006; Zhu, Leonard, and Levin 2005). The Indigo has a highly programmable current injection system. The burst length for each frequency refers to the number of AC cycles of current injected at the specified frequency. Each

of the 30 applied frequencies was given a specific burst length, decreasing step-wise in time for every four frequencies. Using voltages returned from the Indigo device, precise impedances were obtained by performing basic calculations using a calibrated set of current values, as outlined by Bao et al. (Bao, Davis, and Schmukler 1993). Values of  $T_d$  and  $\alpha$  were given to be  $5E-8$  and  $0.7$ , respectively (De Lorenzo et al. 1997; Bolton et al. 1998). To estimate values for  $R_{ECF}$ , the Cole model with De Lorenzo's  $T_d$  compensation formula was used (Equation 3). The MATLAB algorithm *lsqcurvefit* (Mathworks MATLAB R2010a, 2010), was used to optimize values for  $R_{ECF}$ ,  $R_{ICF}$ , and  $C_m$ , based on initial guesses. If the resulting fit is of inadequate accuracy (defined by a user-set limit for a chi-squared value) *fminsearch* was used to estimate variable values. The chi-squared limit was set to  $0.90$  throughout testing, as this proved to be a reasonable delineation between quality data and data with a non-circular impedance locus.

The Cole model predicts a smooth, continuous impedance locus. To improve the accuracy of variable estimation algorithms, certain frequencies were deleted from the impedance locus before algorithm execution. Six frequencies (31 kHz, 38 kHz, 65 kHz, 78 kHz, 130 kHz, and 160 kHz) demonstrated continued misalignment with the locus and were removed. The extent of their deviation was discovered to be due to noise levels in the sensed impedance. The frequencies with the shortest burst lengths were shown to have the highest signal to noise ratio, preventing accurate characterization of the resistance and reactance values at those frequencies. The elimination of these six frequencies improved fit and decreased chi-squared error in the *lsqcurvefit* algorithm.

Once a value for  $R_{ECF}$  had been estimated, extracellular limb fluid volume was estimated using the geometric equation

$$V_{ECF} = \left( \frac{\rho_{ECF} * C}{R_{ECF}} \right)^{2/3} * \frac{L^{5/3}}{(4\pi)^{1/3}} \quad (4)$$

based on work by Fenech and Jaffrin (Fenech and Jaffrin 2004) and used previously by Sanders et al. (Sanders, Rogers, and Abrahamson 2007; Sanders, Harrison, et al. 2012; Sanders et al. 2009). The equation assumes the residual limb is modeled as a truncated cone. Circumferences were measured at each sensing electrode and were averaged to form the variable C (circumference). L represents the distance between electrodes and  $\rho_{ECF}$  is an estimation of extracellular resistivity (assumed to be 39.0  $\Omega\cdot\text{cm}$  in women and 40.5  $\Omega\cdot\text{cm}$  in men)(De Lorenzo et al. 1997). Although specific values for  $\rho_{ECF}$  may have varied between subjects and tests, we did not account for changes in resistivity in our calculations due to the difficulties in quick and cost-efficient estimation of the variable.

## 2.2 Study Design and Procedure

The primary goal of the study was to assess the effect of a period of socket pressure release on limb fluid volume. Additionally, change in volume during subsequent ordinary activity was of interest. The protocol employed activity sequences that included repeated periods of sitting, standing, and walking to mimic everyday activities. A pressure relief period (referred to as the recovery period) was bracketed by two activity sequences.

The study was a repeated measures experimental design with three conditions (ON, OFF, LINER). Subjects completed a full test for each of the experimental conditions. Each test was performed on a separate day with the subject wearing the same socket, liner, and/or socks for all three tests. To the best of our scheduling abilities, each test was performed at the same time of day, as diurnal volume changes are expected among amputees (Sanders et al. 2012; Sanders 2012).

The specific protocol was as follows. Upon arrival, subjects were directed to sit with the prosthesis donned. Subjects sat quietly for 10 minutes to reach homeostasis while answering general questions about diet, activity level, and overall health. Each subjects Socket Comfort Score was also collected

by a prosthetist in attendance (Hanspal, Fisher, and Nieveen 2003). The residual limb was then prepared and bioimpedance electrodes were placed strategically on the limb as described above. Finally, all exposed electrodes were covered with 3M Tegaderm skin adhesive dressings to provide strain relief for each electrode wire and to ensure electrodes remained stationary during use of the prosthesis. Bioimpedance collection was initiated, and the subject donned the prosthesis. Subjects next performed one activity sequence that included three cycles of: a 90 second sit followed by a 90 second stand at equal weight, a five minute walk at a self-selected speed between one and two miles per hour, and a subsequent short 10 second stand at equal weight. After three cycles were completed, subjects were directed to sit for thirty minutes under one of three recovery conditions: socket donned (ON), both socket and liner doffed (OFF), or socket doffed but liner on (LINER). After 30 minutes, the subject repeated three additional cycles of activity. After the end of the final cycle, subjects sat with the prosthesis doffed for 10 minutes to conclude the test.

Previous studies in the laboratory have used cycles of 90s sitting, 90s standing, and 90s walking to emulate general activity (Sanders 2012). Here, time walking was increased from 90s to 5 minutes while time sitting and standing was maintained. Walking time was increased to increase arterial drive in an attempt to encourage volume recovery during the sit with socket doffed.

The 10s stand at the end of walking serves to provide a baseline data point with which to compare volume change during the test. This point was selected as baseline because standing at equal weight represents a known and consistent posture. Sitting or walking positions differed among subjects and were not ideal, standardized baseline conditions.

## 2.3 Subject Selection

**Inclusion Criteria:** amputees were considered for the study if they had a bilateral or unilateral transtibial amputation. As the test included basic activity, it was required that subjects were ambulatory at least at a K-2 level, as defined by the Medicare Functional Classification Level (MFCL) (Anon. 2005). Before testing, a research prosthetist assessed each subject's MFCL level to ensure their ability to walk a total of 30 minutes over the course of testing. Amputees were at least one year post-amputation and had a residual limb longer than 9.0 cm, as measured from the end of the patellar tendon to the distal-most end of the limb. **Exclusion Criteria:** volunteers were excluded if they presented any form of skin breakdown at the time of testing, or if their prosthesis fit poorly, as determined by subjective evaluation of the study prosthetist. Subjects were asked to not consume caffeine or alcohol before arriving for testing and their daily diet was recorded. The study was approved by the University of Washington Human Subjects Division and informed consent was obtained before testing.

## 3 Results

### 3.1 Overview

Volume changes during the OFF 30 minute recovery sit were significantly higher than during ON. We observed that after the limb gained fluid volume during the OFF protocol and, subsequent volume loss was negligible in 12 of 16 subjects during the following three cycles of activity. Conversely, volume lost during the 30 minute recovery period during ON was not recovered during three cycles of activity. During the LINER protocol, volume gains during the 30 minute sit were similar to those on OFF, but during the following three cycles of activity volume returned to baseline levels. Gains during the LINER protocol still remained elevated compared to ON. A repeated measures Analysis of Variance (ANOVA) showed that limb volume change during the post-sit activity sequence was significantly greater during OFF when compared to the ON or LINER protocols ( $p < 0.001$ ).

### 3.2 Results

#### 3.2.1 Participant Demographics

Twenty subjects were recruited from a variety of sources including local practitioners' offices, Harborview Medical Center, and prior lab volunteer lists. Four subjects were discontinued during the study: one due to deteriorating health, one due to loss of contact, and two due to abnormal limb physiology. Of the latter two subjects, one was found to have had titanium reconstruction of the lower knee and upper tibia. The implant affected electrical impedance of the limb and introduced error into the bioimpedance analysis. Sensed impedance values were well below the calibrated range of the Indigo device. Due to this abnormal physiology, the subject was discontinued. One subject had a Syme amputation (i.e. ankle disarticulation) producing a residual limb of considerable length and little tissue. As a Syme amputation does not represent transtibial limb loss, the subject did not meet inclusion criteria and was discontinued. Thus, 16 subjects completed the study protocol. Fourteen



subjects had a unilateral amputation and two had bilateral transtibial amputations. Two subjects were unable to complete the LINER protocol: one subject did not wear an elastomeric liner and so performed only ON and OFF study protocols, and one subject became bedridden before completion of the LINER protocol. Both subjects were thus included in the OFF and ON protocol analysis, but were omitted from the LINER. Due to the rigor of the test (a combined 30 minutes walking), subjects were generally of higher functional level, with only three K-2 level amputees, six K-3, and seven K-4. Seven have been diagnosed with comorbidities (diabetes, peripheral arterial disease, or obesity of BMI > 30). Four subjects were regular smokers. Three of 16 were female. The average age of participants was 52.8 (s.d.= 13.1) years. Time since amputation ranged from 1 to 52 years with a mean of 17.9 years. Mean BMI was 28.1 (s.d.= 6.8) kg/m<sup>2</sup>, uncorrected for differences in prosthetic mass as compared to anatomical limb mass. Mean mass was 89.3 (s.d.= 15.4) kg measured with prosthesis on. 11 subjects regularly used an elastomeric liner with pin, two used a vacuum system, two wore a sleeve, and one utilized a lanyard system (individual demographic data presented in Table 3.1).

Subject No.	Years Since Amputation	Age	Mass	BMI	Obesity	Etiology	Suspension	Socket Age (yrs)
1	17	45	76.8	23.0	No	trauma	pin	3.5
2	1	31	83.7	28.0	No	DM Type1	pin	0.1
3	2	36	98.2	26.0	No	Trauma	pin	0.5
4	26	46	78.2	22.0	No	Trauma	pin	4.5
5	8	65	72.7	23.0	No	Trauma	pin	5
6	34	70	83.2	25.0	No	Trauma	vacuum	6
7	52	71	87.0	25.0	No	Trauma	pin	1.2
8	5	58	80.9	25.6	No	Trauma	pin	0.1
9	22	49	100.0	30.2	Yes	Trauma	pin	6
10	9	56	100.0	35.0	Yes	Trauma	lanyard	1.5
11	9	29	59.1	22.0	No	Trauma	vacuum	2
12	12	60	114.0	43.0	Yes	DM Type 2	sleeve	3
13	45	69	99.5	33.8	Yes	Trauma	sleeve	0.4
14	11	56	108.0	31.7	Yes	Trauma	pin	4
15	5	52	109.5	35.8	Yes	Trauma	pin	1.5
16	28	52	77.3	21.0	No	Trauma	pin	0.5

Subject No.	MFCL Level	Diabetes	Venous Stasis	HBP	PAD	Smoker	Socks used daily	Comorbidity
1	K-4	n	n	n	no	yes	0.5	no
2	K-3	y	NA	Y	no*	yes	0-6	yes
3	K-3	n	n	n	no	no	0	no
4	K-3	n	n	n	no	no	0	no
5	K-4	n	n	n	no	no	0	no
6	K-4	n	n	n	no	no	0-2	no
7	K-3	n	n	n	no	no	0	no
8	K-4	n	n	n	no	no	3	no
9	K-4	n	y	y	no	no	0	yes
10	K-2	n	y	y	yes	no	1	yes
11	K-4	n	n	n	no	no	0	no
12	K-2	y	NA	y	yes	yes	0	yes
13	K-3	n	y	y	yes	yes	0	yes
14	K-3	n	NA	Y	no*	no	0	yes
15	K-2	n	n	y	no	no	0	yes
16	K-4	n	y	n	no	no	0-2	no

Table 3.1: Demographic data for study population.

\* indicates diagnosis of subclinical PAD.

### 3.2.2 Collected Bioimpedance

Subjects were tested three times on three separate occasions to perform the ON, OFF, and LINER protocols individually. Sample data collected during OFF test is shown in Figure 3.1.

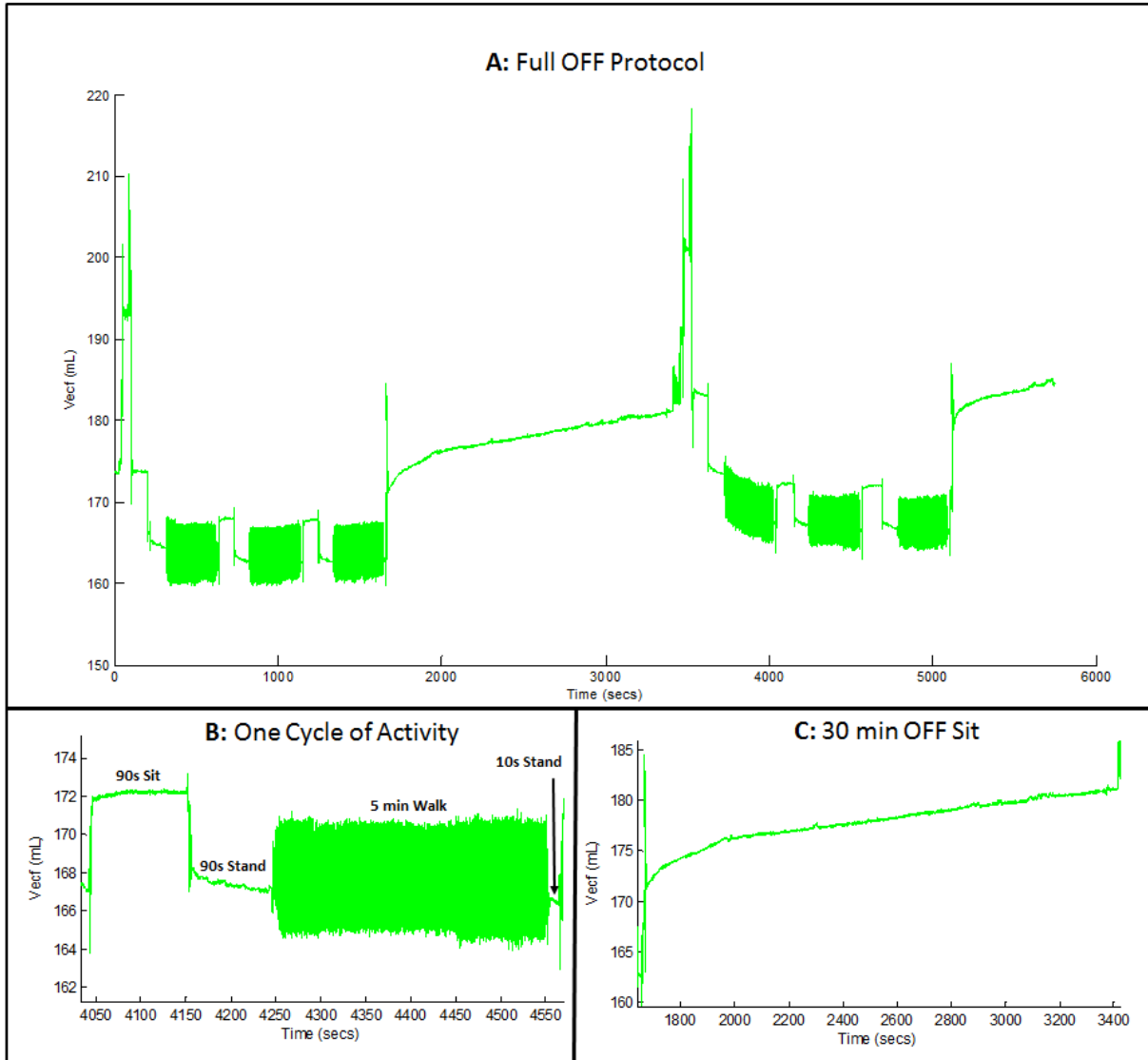

**Figure 3.1: Sample data collected during OFF test for one subject. In A, each of the six cycles are clearly visible. B shows a breakdown of one cycle. C contains the volume change curve for one 30 minute sit with socket doffed (OFF).**

The equal weight 10s stands after walk were used as baseline comparisons to determine relative volume change throughout the test, seen in Figure 3.1 B. Volume data during the 30 minute recovery sit was also collected (Figure 3.1 C).

### 3.2.3 Recovery Period Fluid Volume Change

For all 16 subjects, limb volume was lost during the 30 minute recovery period with the socket donned (ON). Volume change during the sit was calculated as  $(\text{Vol at 30 min} - \text{Vol at sit begin}) / (\text{Vol at sit begin})$ , where the 'sit begin' was the first identifiable, stable data point after socket removal. On average subjects lost 2.2% (s.d. = 1.3%) of limb fluid volume with a range of 0.1% - 4.1%. However, all subjects gained an average 4.6% (s.d. = 2.1%, range 2.0% - 9.0%) fluid volume during the recovery period when doffing the socket (OFF). Limb fluid volume change during the 30 minute sit with the socket doffed and liner donned (LINER) produced volume gains similar to removing the liner and prosthesis (OFF), with an average volume gain of 5.1% (s.d. = 3.7%, range = 0.2%-12.4%).

The large standard deviation for volume gain during the OFF and LINER tests is due in some part to subject movement. Without a prosthesis to anchor the limb, some subjects moved their residual limb as they situated themselves comfortably in the chair. These movements induced rapid changes into the bioimpedance data, obscuring the initial period of doffing. We attempted to manage this problem by establishing tape heel markers on the ground for the contralateral limb to ensure consistent posture and by coaching the subject before testing to release the residual limb to a consistent and comfortable position. Once the subject reached a calm and consistent posture, fluid volume change was consistent and easily identifiable. However, because the largest and most rapid volume gain occurs within the first few seconds of doffing (Sanders, Rogers, and Abrahamson 2007), motion artifacts noted here may have caused underestimation of overall volume changes, most notably during the OFF protocol.

Using a repeated measures ANOVA, we can state that the differences between average volume gains in the three recovery conditions (ON, OFF, LINER) were statistically significant with  $p < 0.001$ . A Bonferroni Comparison confirmed that volume gains during OFF were statistically elevated as

compared to ON ( $p < 0.001$ ), and that volume gains during LINER were statistically elevated as compared to ON ( $p < 0.01$ ). A statistically significant difference did not exist between OFF and LINER volume change.

### **3.2.4 Effect of Recovery Period on Fluid Volume During Activity**

Pressure applied to the limb during the doffing period was shown to have a direct effect on fluid volume levels during subsequent activity. To assess fluid volume change after the recovery period, we compared the volume from the 10s stand at the end of the fourth cycle to the 10s stand at the end of the third cycle. The percent difference between these two points represents limb volume change during the recovery sit and one cycle of activity, hereby referred to as “short-term volume change.” Based on our initial hypothesis, we expected volume to increase during the sit and remain elevated after the fourth cycle during the OFF and LINER tests. However, we expect volume to decrease and remain decreased during the ON test.

We found that short-term volume change remained negative for all 16 subjects during ON. Volume change during ON was, on average  $-2.2\%$  (s.d.=  $0.8\%$ , range =  $-0.8\%$  to  $-3.3\%$ ). During the OFF test, 13 of 16 subjects showed volume increase in the short-term. Three subjects, all of whom gained volume during the 30 minute sit, rapidly lost volume during the fourth cycle of activity, negating some but not all volume increase during recovery sit. On average subjects gained  $2.5\%$  (s.d.= $2.5\%$ , range =  $-2.0\%$  -  $8.2\%$ ) volume in the short-term. Of the 14 subjects who completed the LINER protocol, eight showed short-term volume gain while six showed short-term volume loss. On average, subjects gained  $0.1\%$  (s.d.= $1.6\%$ , range =  $-2.6\%$  –  $3.0\%$ ) in the short-term during LINER. We used a repeated measures ANOVA with two factors to determine whether differences existed between short-term changes in ON, OFF, and LINER protocols. The ANOVA showed that the interactions between the three sitting conditions were statistically significant ( $p = 0.01$ ), using the Greenhouse-Geisser

adjustment for lack of sphericity. A Bonferroni analysis showed that differences between tests were each statistically significant ( $p < 0.01$  in all cases). Therefore, the average change in volume between the fourth and third cycles likely depends on the recovery period condition (ON, OFF, LINER).

Subsequent to the fourth cycle, subjects performed two more cycles of activity. The volume change between the 10 s stand at the end of the sixth cycle and the 10 s stand at the end of the third cycle represents volume change through the 30 minute sit and three subsequent cycles of activity, hereby referred to as “long-term volume change.” Based on our initial hypothesis, we would expect volume

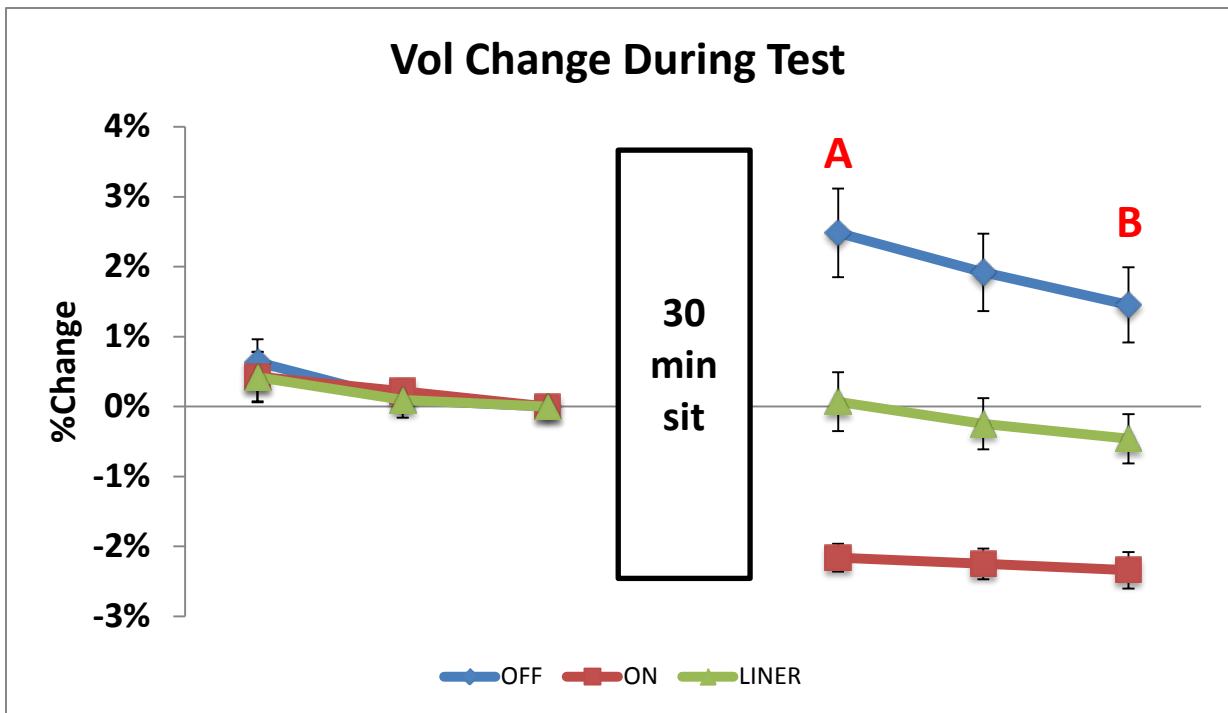

Figure 3.2: Average change in volume across all subjects for each protocol, normalized to the 10s stand after the third cycle. Standard error is shown as error bars. Short-term volume change is shown at time ‘A’ while long-term volume change is shown at time ‘B’.

to remain elevated during the OFF and LINER tests, but remain decreased during the ON test, as seen in the short-term. In all cases we would anticipate that the volume change between the sixth and third cycles would be lower than between the fourth and third cycles, as the pressures induced by two additional cycles of activity serve to drive fluid out of the limb. We similarly used a repeated

measures ANOVA to assess differences in volume change between the sixth and third walks. The test showed statistical significance between each of the three conditions (ON, OFF, LINER) with  $p=0.01$ . A Bonferroni analysis showed that differences between tests were each statistically significant ( $p < 0.01$  in all cases). Therefore, the average change in volume between the sixth and third cycles (long-term volume change) likely depends on the recovery period condition.

In Figure 3.2, a plot of limb fluid volume during the 10s stand after walk is shown for each of the test's six cycles. To summarize, there was an average gain in limb fluid volume due to the 30 minute recovery period in the OFF test, and this volume gain persisted through the sixth cycle of activity. During the ON test, subjects on average lost volume in the recovery period and continued to show decreased volume through the end of the sixth walk. The LINER test showed negligible average gains after the fourth and sixth cycles, but was still significantly elevated as compared to ON.

### **3.2.5 Subject and Demographic Analysis**

In an exploratory effort, we attempted to correlate volume change during the sit, short-term, and long-term with accumulated demographic data in Table 3.1. Demographic data was compared with results of volume change using linear relationship analysis and calculating respective R-coefficients. We observed no strong relationships between any metric of volume change and the listed demographics.

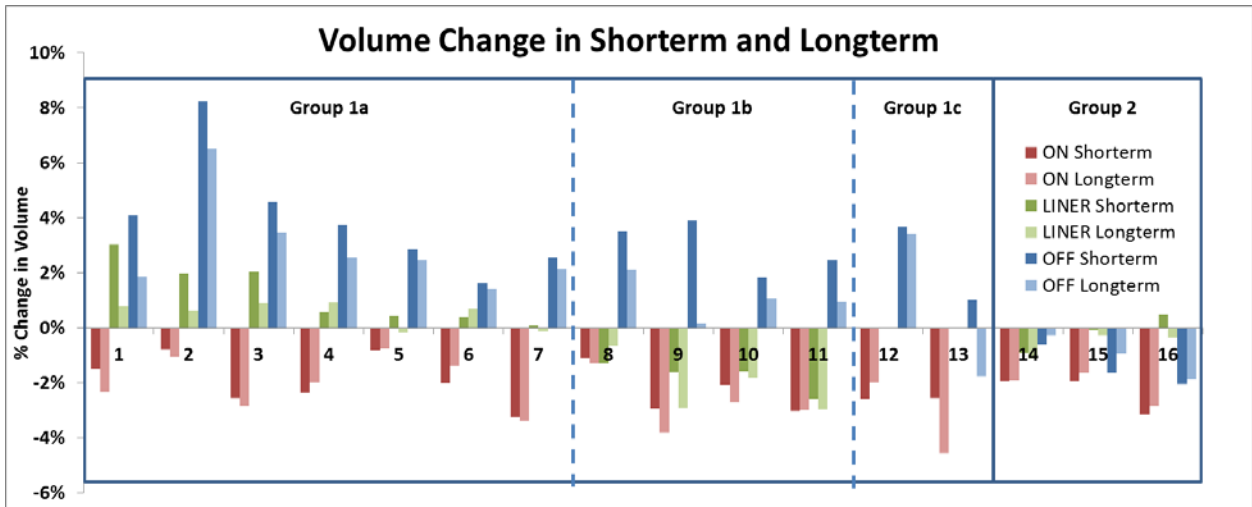

Figure 3.3: Long-Term and Short-Term Volume Change for each of the three protocols, presented on a subject-by-subject basis.

Subjects were separated into two major categories based on their short-term volume change during the three protocols (Figure 3.3). As all subjects lost volume during ON, groups 1 and 2 are separated by their response in OFF, with group 1 showing volume gain in the short term, and group 2 showing volume loss. Group 1 is separated into three parts – subjects who showed short-term volume gains during the LINER protocol (Group 1a), subjects who showed short-term volume loss during the LINER protocol (Group 1b) and subjects who did not complete the LINER test (Group 1c). Of clinical importance is the fact that for most subjects (12 of 16) volume was gained during the recovery period with socket off, and that increase in volume was carried over into the short and long term volume changes. This observation supports the notion that a prosthetic user might regain lost fluid volume by doffing the prosthesis.

It was observed that Group 1a consisted of subjects of lower body mass and BMI, with 0 of 7 demonstrating clinical obesity (BMI > 30). On the contrary, 2 of 4 in Group 1b were obese and 2 of 3 in Group 2. No further demographic trends were observed between subgroups, considering all other variables listed in Table 3.1.



### 3.3 Conclusion

All subjects who sat for 30 minutes with the prosthesis donned lost limb fluid volume and did not regain volume during subsequent cycles of activity. Subjects experienced a fluid volume gain after doffing the prosthesis and liner for 30 minutes. This fluid volume gain persisted during subsequent cycles of activity. Subjects who sat for 30 minutes with the prosthesis doffed and the liner donned gained fluid volume but returned to pre-sit volume levels during subsequent activity. Fluid volumes during activity remained elevated compared to donning the prosthesis during the recovery period.

## 4 Discussion

The ability to selectively return volume to the residual limb is a potential mechanism to address fluid volume loss. Currently, an amputee that experiences volume loss over the course of a day must tolerate or accommodate for a deteriorating socket fit. The shrinking residual limb is also at risk for increased pressures and interface stresses, causing skin breakdown and discomfort on weight-bearing or bony sections of the limb. Clinicians primarily advise amputees to compensate for volume loss by adding socks to take the place of lost fluid volume, thus maintaining size agreement between limb and prosthesis. However, donning sock ply contributes to continued limb fluid volume loss in most subjects (Sanders, Cagle, Harrison, et al. 2012) and may exacerbate limb fluid volume loss. Returning lost volume using relief of socket pressure as described here may mitigate the need to add socks by returning the limb to a more ideal size and shape, thus maintaining a comfortable and healthy socket fit.

Results of this study show that relief of socket pressure generates an immediate volume gain in the residual limb. Furthermore, this gain in volume persists through the donning of the prosthesis and repeated activity and ambulation.

Because our study required 30 total minutes of walking, many subjects were initially rejected due to health concerns, age, or other factors that might hinder their ability to complete the protocol. Study participants were consequently of relatively high K-Levels in comparison to the trans-tibial amputee population as a whole. Additionally, the study population contained few subjects with peripheral arterial disease, diabetes, venous insufficiency, or other comorbidities that may be associated with fluid volume change. Consequently, the population of available participants was diminished, preventing a more comprehensive study of disease effect. Inclusion criteria also stipulated that volunteers be at least 12 months post-amputation. In fact, all but two subjects were five or more

years post-amputation. The physiology of post-operative amputees can be markedly different from those many years removed. Edema, arterial and venous insufficiency, and overall fluctuation in limb shape and size are more commonplace as the limb slowly remodels (Smith et al. 2003). Therefore, testing on early postoperative amputees might produce different trends in volume change than the trends presented here.

#### **4.1 Physiological Investigation and Hypothesis**

A question remains, however – what is the physiological explanation for the dramatic differences in limb volume between ON, OFF, and LINER? Externally applied pressure may help to provide a physiological answer. Externally applied pressure to the limb has the effect of increasing interstitial fluid pressure, causing the venous system to evacuate blood and interstitial fluid out of the residuum. When the amputee sits for 30 minutes with prosthesis donned, internal pressures remain elevated and the limb is unable to regain volume. This was true for all 16 subjects tested, who continued to lose volume when they sat with socket donned. However, when the socket and liner are doffed, exerted pressures are released and interstitial pressure drops. This allows the venous vasculature to enlarge and fill with blood, and drives ECF into the interstitial space. We propose that limb fluid volume increases in a biphasic fashion corresponding to the differing influx rates of blood plasma and interstitial fluid. Sanders et al. have theorized that upon doffing a prosthesis, the early and rapid part of fluid volume response curve is primarily due to blood volume returning to the residual limb (Sanders, Harrison, et al. 2012). However, the slow but continued volume gain exhibited during subsequent cycles of activity reflects primarily interstitial fluid increase (Figure 4.2).

After 30 minutes of sit, the limb has swelled sufficiently with both blood and interstitial fluid. However when the socket and liner are donned, external pressures are returned to elevated levels. Just as the inflow of blood occurs rapidly, so does the outflow. Thus the donning of the socket is

thought to cause the evacuation of much of the blood volume gained during sit. For this reason, the long-term fluid volume gain exhibited during the OFF and LINER protocols is likely due to interstitial fluid volume gain. Long-term volume gain was not seen in four participants. For one of these participants (no. 13 in Table 3.1), volume gain occurred in the short-term, but was lost during subsequent activity. Likely this is explained by the same factors that caused fluid volume loss with the prosthesis donned. Internal pressures in the limb rise when the socket is donned and the amputee ambulates. These internal pressures evacuate the venous vasculature and drive fluid out of the interstitium.

However, the remaining three subjects (nos. 14-16) showed the first, second, and fourth highest volume gains during walking periods of subjects not wearing vacuum systems (which, by design, promote volume gains during walking). As heart rate rises and drives blood into the limb, the vascular system may be unable to clear blood flow rapidly, thus leading to general volume gain. Increased blood pressure also promotes fluid flow into the interstitium. Thus, when the prosthesis is doffed, the limb may be already swollen, preventing significant volume gain during doff. It remains to be seen whether these behaviors can be predicted by vascular health.

Two subjects wearing vacuum-assisted prostheses (nos. 6 and 11) were included in testing. Vacuum suspension sockets apply a negative pressure to the distal portion of the limb thus facilitating fluid volume drive, as previously mentioned. Therefore, we might have expected to see diminished volume loss during the recovery sit in ON. However, both subjects showed typical volume loss during the recovery sit of 3.0% and 2.0% for subjects 6 and 11, respectively. Other general volume change trends, including both short and long-term volume change, were consistent with group averages during OFF, ON, and LINER protocols (Figure 3.3).

One objective of this study was to assess if a period of decreased pressure produces a long-lasting volume increase in the limb. If volume is gained during pressure release but is quickly lost, the technique will not produce a lasting effect. To this end, we investigated the rate of fluid volume loss during the post-recovery period of activity. During all three testing protocols, average fluid volume change is lower in the long-term than the short-term as subjects continue to wear the prosthesis (Table 4.1). Likely this decrease is due to increased pressure generated by wearing the prosthesis, and further contributed to by the pressures generated in ambulation. The difference between average short-term and long-term is largest in OFF, when the most volume was gained, and lowest during ON, when volume was lost. At first glance these data seem to imply that subjects are more rapidly losing volume after a volume gain, perhaps trending towards some global homeostasis.

	$\Delta$ Short-Term	$\Delta$ Long-Term
OFF	2.5% ( $\pm$ 2.5%)	1.5% ( $\pm$ 2.1%)
ON	-2.2% ( $\pm$ 0.8%)	-2.3% ( $\pm$ 1.0%)
LINER	0.1% ( $\pm$ 1.6%)	-0.5% ( $\pm$ 1.3%)

**Table 4.1:** Table showing the average volume change in the short-term (fourth stand after walk – third stand after walk) and long-term (sixth stand after walk – third stand after walk).

However, the significant drop in average volume gain is largely due to results from a minority of the study subjects. We examined the rate of volume loss during cycles of activity before and after the 30 minute sit. The percent volume lost between the 10s stand after cycle 1 and the 10s stand after cycle 3 is referred to as  $\Delta$ pre. The percent volume lost between the 10 s stand after cycle 4 and the 10 s stand after cycle 6 is referred to as  $\Delta$ post. Both  $\Delta$ pre and  $\Delta$ post represent the rate of volume change during activity. If positive, this would imply that volume was being gained during sitting, standing, and walking while if negative, it would imply volume loss. Our initial assumption was that the limb would exhibit a control reaction after shrinking or swelling during sit, returning limb volume to some

homeostatic value during subsequent activity. Under this hypothesis, volume growth during the 30 minute OFF sit would cause  $\Delta_{\text{post}}$  to be more negative than  $\Delta_{\text{pre}}$  as the limb forced out fluid gained during sit. Similarly, our hypothesis predicted that volume loss during the 30 minute ON sit would cause  $\Delta_{\text{post}}$  to be more positive than  $\Delta_{\text{pre}}$  as the limb was closer to a “minimum volume.” To examine this hypothesis, we plotted  $\Delta_{\text{pre}}$  and  $\Delta_{\text{post}}$  as the tail and tip of an arrow in Figure 4.1. We expected arrows for OFF to point in the negative direction (implying greater volume loss after the sit), and for ON to point positive. Contrary to this hypothesis however, none of the 16 tested subjects exhibited both a negative arrow for OFF and a positive arrow for ON. Surprisingly, 10 out of 16 subjects show arrows consistent in sign between ON and OFF tests, either both positive or both negative. These 10 subjects are outlined in green. For these 10 subjects, the implication is that the limb did not exhibit a control reaction to return the limb to some ideal homeostatic level. Put another way, fluid volume change after the 30 minute sit is not directly a result of fluid volume change during the sit. This conclusion helps to further support the hypothesis that pressure release is a viable method to increase fluid volume long-term.

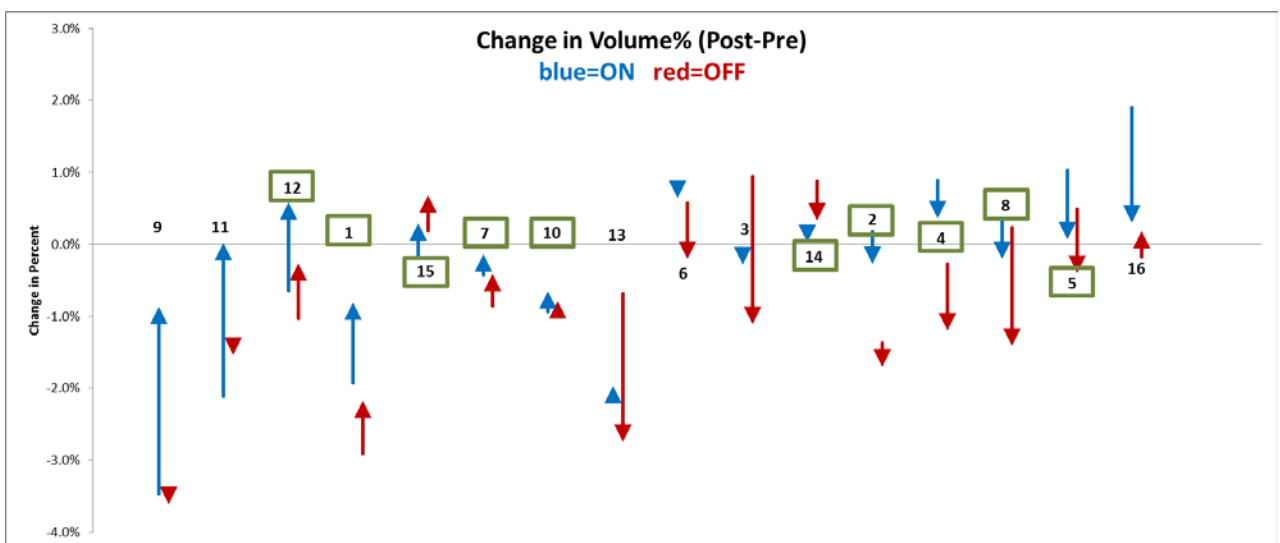

Figure 4.1: Comparison of  $\Delta_{\text{pre}}$  and  $\Delta_{\text{post}}$  for both ON and OFF tests. Tail of each arrow represents  $\Delta_{\text{pre}}$  while the head shows  $\Delta_{\text{post}}$ . Subjects outlined in green show agreement between the direction of the arrow among ON and OFF.

While pressure release is a viable method to increase fluid volume, utilizing pressure release to accurately regulate fluid volume change presents a challenge. We might imagine that for the socket to properly function, limb fluid volume must remain within some volume “range”. Figure 4.2 shows an illustration of generalized fluid volume loss over the course of the day. When volume begins to reach the lower boundary of a perceived “target range”, the socket user decreases pressure on the residual limb and recovers fluid volume. This recovery produces a volume gain to near the upper limit of the “target range,” and though fluid volume continues to be lost after this recovery volume remains within an acceptable range.

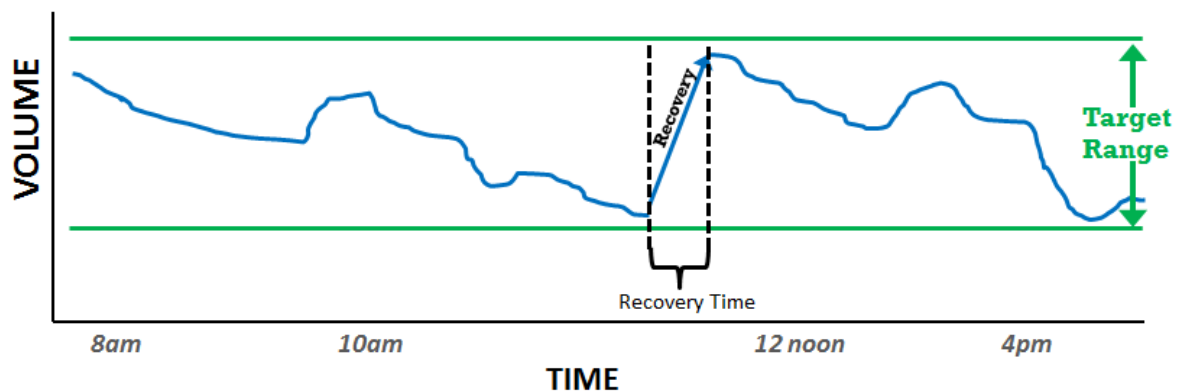

Figure 4.2: Author’s rendition of volume change over the course of a day. Green bars represent a “target range” in which limb fluid volume produces an acceptable socket fit. A recovery period is induced when the subject senses a loose socket, much as a prosthesis user might identify when sock ply should be added.

How do we determine the boundaries of an acceptable “target range?” In current prosthetic practice, socket users determine when to add sock ply based on self-identified sensations of loose socket fit or volume loss. Similarly, the point at which a user chooses to induce a volume recovery may be self-identified by sensations of loose socket fit. Determining the upper boundary of the “target range” is more complex. Recovering excessive fluid volume will create difficulty properly fitting the limb into the prosthesis, and can result in decreased blood flow and ischemia. Future

research in our laboratory aims to develop a portable bioimpedance system to collect limb fluid volume data over a period of many days. It should be possible to use this device to determine daily maximum and minimum fluid volumes of the residual limb. In conjunction with detailed feedback from subjects, it should be possible to ascertain at what times subjects report a loose-fitting prosthesis (i.e. when users might ordinarily don socket ply) and at what times users report feeling swollen or highly compressed within the prosthesis. By comparing feedback with collected bioimpedance data it should be possible to determine a window of self-reported agreeable socket fit. This method would require characterization for each subject and each new socket and could be potentially time-consuming.

Alternatively, collection of bioimpedance simultaneous with measurements of interface pressures or shear stresses would allow quantification of poor socket fit. When pressures or shear stresses reach clinically elevated values over the course of the day, collected bioimpedance could be used to determine what limits of limb fluid volume produced unacceptable pressures or shear stresses.

## **4.2 Effects of a Prosthetic Liner**

During the LINER test, fewer subjects showed a volume gain after the doffing period and three cycles of activity. The elastic liners worn during the doffing period apply an external pressure to the residual limb. This pressure is less than the pressure applied by the socket, but is likely sufficient to curtail fluid volume gain during the recovery period. In Figure 4.3 we see that fluid volume gain during the recovery period in the LINER protocol rapidly reaches a plateau, and may even decrease marginally over the final 20 minutes of the sit. Conversely, with the liner doffed in the OFF condition, volume rapidly rises initially and then approaches a constant positive slope. The initial rapid volume increase during both LINER and OFF is likely explained by an influx of blood into the vascular system. The slower, more constant volume growth exhibited by the positive linear volume increase of the OFF



curve is attributable to the continued flow of fluid into the interstitial space. It is thought that the transport of blood volume out of the venous system is a relatively fast process in comparison with the rate of interstitial fluid transport. Fluid volume gain during LINER therefore reaches a plateau because increased internal pressures are sufficient to prevent continued fluid volume flow into the interstitial space. However these pressures are not high enough to prevent volume gain of the vasculature. With the liner doffed, the pressure gradient into the interstitial space is high. Without any outside forces to resist this pressure gradient, the fluid volume of the interstitial space continues to grow over the 30 minute doffing period.

Therefore, the absolute magnitude volume gain during sit is comparable between LINER and OFF, although it is likely that less interstitial fluid is gained during LINER than during OFF. When the subject subsequently dons the socket and begins ambulating, the rapid fluid volume gain in the vasculature is quickly erased as the applied pressure from the socket evacuates the veins. However, as the interstitial space provides a stronger barrier to movement than the venous system, the interstitial fluid volume gained during OFF persists throughout the ensuing ambulation causing fluid volumes during OFF to be higher than in LINER after three cycles of activity.

Percent volume gain during the recovery sit may be overestimated during the LINER protocol due to our measurement technique. To calculate percent volume change during sit, volume at the end of the 30 minute sit is compared to the earliest available data point of the sit. During the OFF test, bioimpedance data fluctuates widely while the prosthesis and liner are doffed, delaying the time to a reliable data point. Only once the subject has reached a stable posture do volume measurements become reliable. However, during the LINER protocol, the extra step of removing the liner is not performed, meaning that subjects reach a stable posture more rapidly by approximately 1-2 seconds. Since fluid volume rises quickly and immediately after doffing the prosthesis, the LINER doffing curve

captures 1-2 more seconds of initial volume gain than does the OFF doffing curve. Attempts were made to offset the selected start point of the LINER doffing curve in post processing, and we estimated a maximum time of two additional seconds. While offsetting the initial reference point for the LINER doff curve by two seconds served to decrease overall estimation of volume gain, LINER gain remained elevated when compared to OFF. The difference between LINER and OFF may be further explained by positional changes in the limb caused by the elastic properties of the liner. When sitting with the limb at rest in a comfortable position, the liner causes the limb to rest at a larger angle than when sitting with liner doffed. Furthermore, the liner provides cushion on the posterior aspect of the thigh, potentially preventing minor occlusion of the popliteal artery-vein pair. Leg angle and added cushion may affect fluid volume transport into and out of the limb. The time to doff the liner may be a factor explaining the difference in doffing curves between LINER and OFF, but does not entirely account for the larger volume gain seen during LINER. Consequently, the magnitude of fluid volume change in Figure 4.3 may be artificially high for the LINER protocol, as compared to OFF.

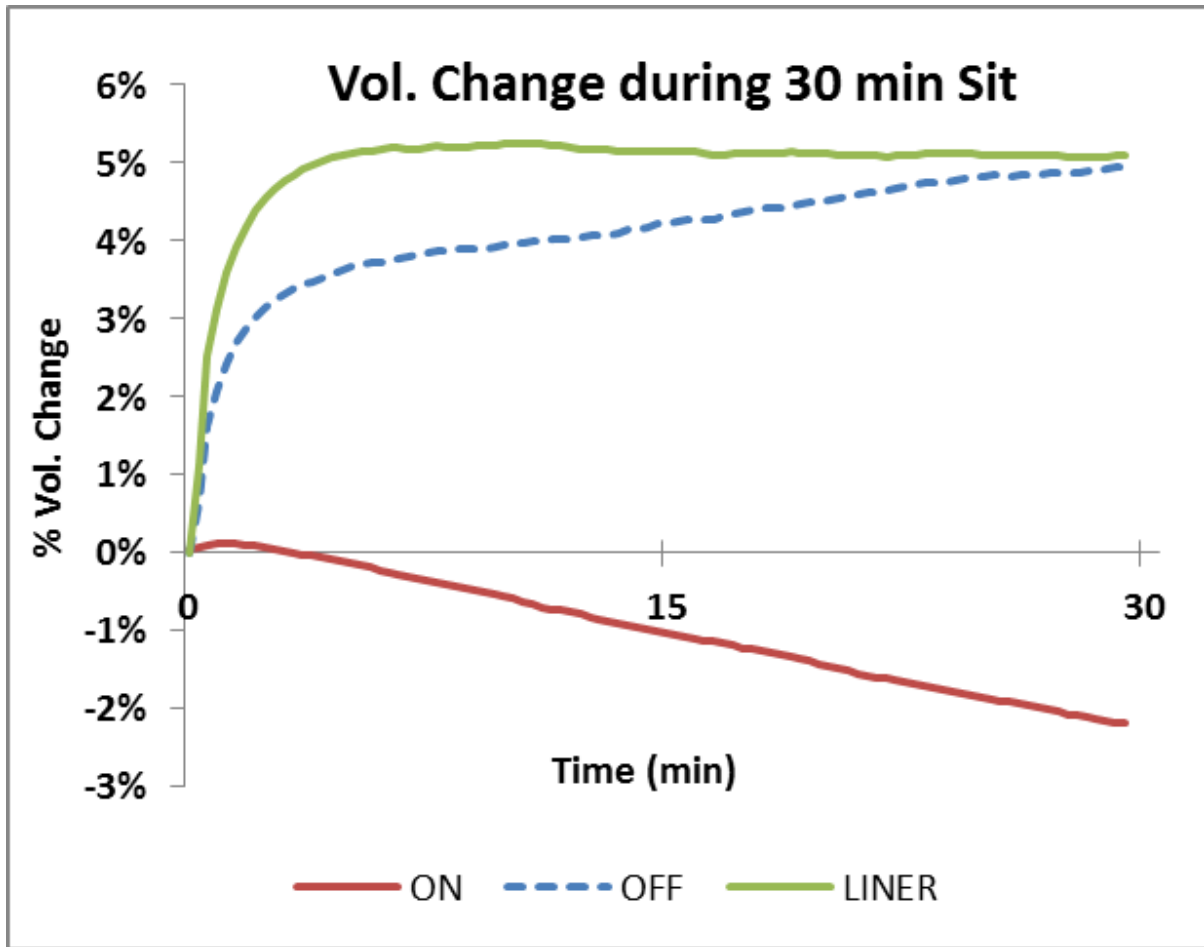

Figure 4.3: Volume change during the 30 minute recovery period at sit.

### 4.3 Variation between Anterior and Posterior Measurements

Measurements from the posterior region have been presented throughout this thesis, however data was collected simultaneously from the anterior and posterior regions. Throughout testing, fluid volume was largely similar between the two channels. Furthermore, both channels exhibited consistent trends in fluid volume change during the recovery sit and subsequent activity in the ON and OFF protocols. However, anterior and posterior volume measurements differed during the recovery sit, short-term activity, and long-term activity of the LINER test. Short-term volume change measured from the anterior compartment was 0.7% (s.d. = 1.3%) on average. Conversely, short-term

change from the posterior was 0.1% (s.d. = 1.6%) (Figure 4.4). Using a repeated-measures t-test, the difference between average short-term anterior and posterior measurements was shown to be statistically significant ( $p < 0.01$ ). On a case by case basis, 12 of 14 subjects exhibited higher short-term gains in the anterior than the posterior. Results were also different in long-term volume change, with 0.1% (s.d. = 1.0%) anterior volume gain and -0.5% (s.d. 1.3%) volume change in the posterior. Using a repeated-measures t-test, the difference between average long-term anterior and posterior measurements was shown to be statistically significant ( $p < 0.05$ ). 10 of 14 subjects exhibited higher long-term fluid volume in the anterior than posterior. These results imply that the anterior compartment is gaining more volume than the posterior during the recovery sit and the volume gain is maintained through the short and long-term.

Examining the volume change during the recovery sit in LINER, we find that the average anterior and posterior doffing curves exhibit dissimilar trends (Figure 4.5). The posterior volume stabilizes soon after doffing while the anterior compartment continues to increase in volume at a roughly linear rate. Taking the hypothesis given by Sanders et al. that rapid volume change is largely due to blood volume while gradual volume change is due to interstitial fluid gain, we might postulate that the slope of volume gain in the anterior represents a gradual increase in interstitial fluid volume (Sanders, Harrison, et al. 2012). The posterior does not show a positive slope of volume gain after the initial rise, and in fact may decrease slightly over time. If we accept Sanders' biphasic hypothesis of fluid volume change from section 4.1, we would then conclude that the anterior is gaining more interstitial fluid volume than the posterior compartment.

We have previously stated that interstitial fluid volume change (and not blood plasma or ICF change) may be the primary factor affecting short and long-term volume change. Consequently, the higher

slope of anterior volume change in Figure 4.5 may help explain the differences in anterior and posterior short and long-term volume gains from Figure 4.4.

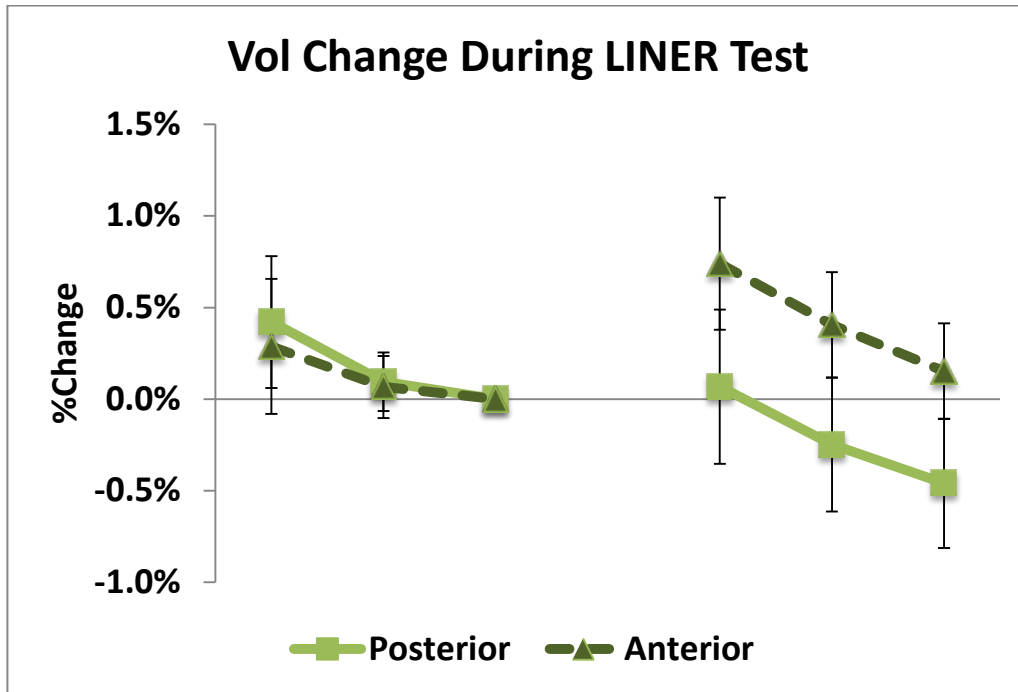

Figure 4.4: A comparison of volume change during LINER test for whole anterior and whole posterior measurements. Each data point represents one equal weight stand after walk.

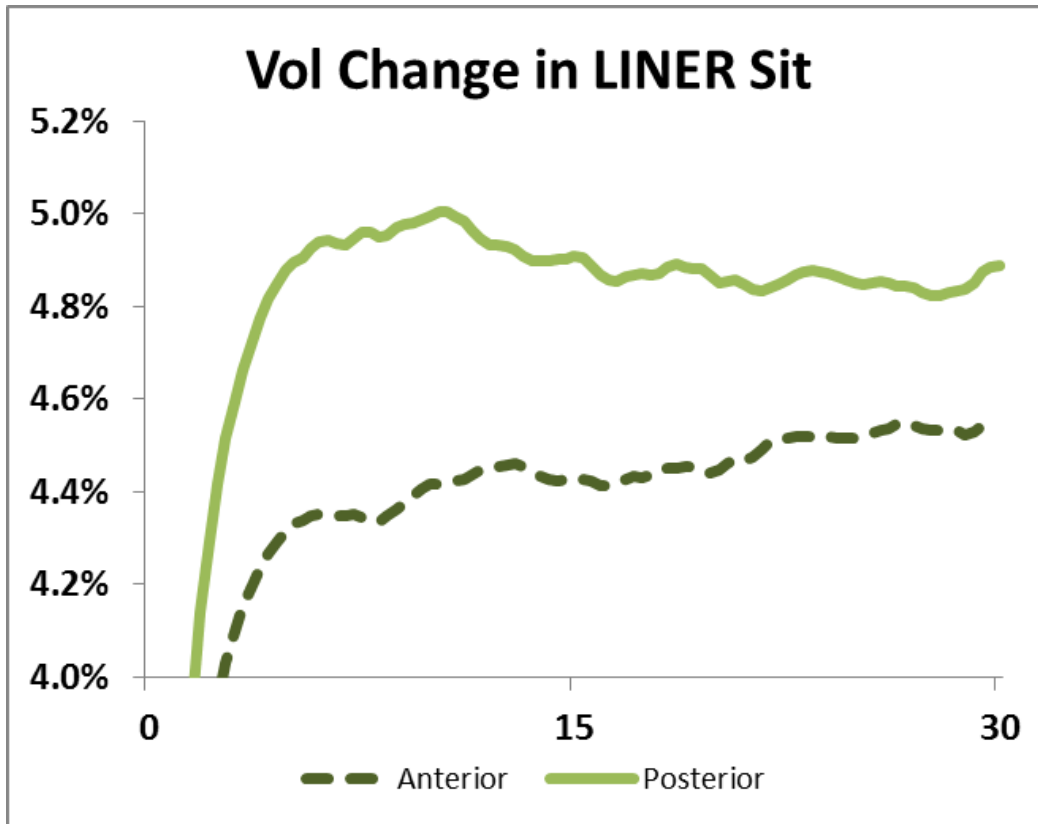

Figure 4.5: Change in volume during the LINER test 30 minute recovery period for anterior and posterior.

The question still remains: what would cause anterior and posterior interstitial fluid volume change to be different during the LINER test but not ON or OFF? The most likely cause is from non-homogeneous pressures applied by the liner itself. Many amputees have a non-conical residual limb and may have bony protuberances or features that prevent a perfectly conical shape. Commonly the tibial crest may be prominent, producing a limb shape similar to Figure 4.6 which shows low areas of concave curvature medial and lateral to the tibia. However, elastomeric liners are manufactured to a conical design (Klute, Glaister, and Berge 2010). Therefore it is possible that when the liner is applied to a residual limb with morphology similar to Figure 4.6, hammocking is induced over the antereolateral and/or antereomedial section of the limb, reducing contact between liner and skin and thus decreasing applied pressure. Measurements of liner pressure made in our laboratory using

force sensors placed over the residual limb show pressures generated by liner on the skin surface for one test subject (Table 4.2). Measurements of liner pressure over the antereomedial and antereolateral tissue are at or near zero when the subject's normal liner was donned. Pressures were also near zero when wearing a new liner of the same type. The subject also donned an abnormally small liner in an attempt to increase applied pressure, yet pressures over the antereolateral tissue remained zero.

Subject No. 5 Liner Pressures (kPa)							
	Anterior			Posterior			
Amputation	Medial	Mid	Lateral	Medial	Mid	Lateral	Notes
Right	0.47	8.11	0.00	1.43	5.24	0.00	Normal Liner
Right	0.47	19.08	0.00	1.38	2.38	2.38	New Liner
Right	5.24	21.94	0.00	2.38	8.11	2.38	Artificially Tight Liner

**Table 4.2:** Liner pressures from subject no. 5 (data by Christian Redd). Normal liner refers to the liner ordinarily worn by the subject. New liner was a new version of the normal liner. The artificially tight liner was of the same thickness and manufacture as normal and new, but one size smaller. Yellow cells represent pressures high enough to occlude blood flow (Thirsk, Kamm, and Shapiro 1980).

Note that anterior sensing electrodes are placed over the antereolateral section of the limb while posterior electrodes are over the mid-posterior. In Table 4.2 we can see there is no pressure applied to the antereolateral area containing the anterior electrodes while significant pressure is applied to the posterior area which contains the posterior electrodes. The pressure values highlighted in yellow are significantly high to occlude blood flow (Thirsk, Kamm, and Shapiro 1980; Kydd and Daly 1982), and occur primarily in the mid anterior (over the tibia) and over the mid posterior. Given this data, we might infer that the pressure applied by the liner to the posterior section of the limb is preventing some interstitial fluid volume gain, thus decreasing short-term and long-term volume gain in the LINER test.

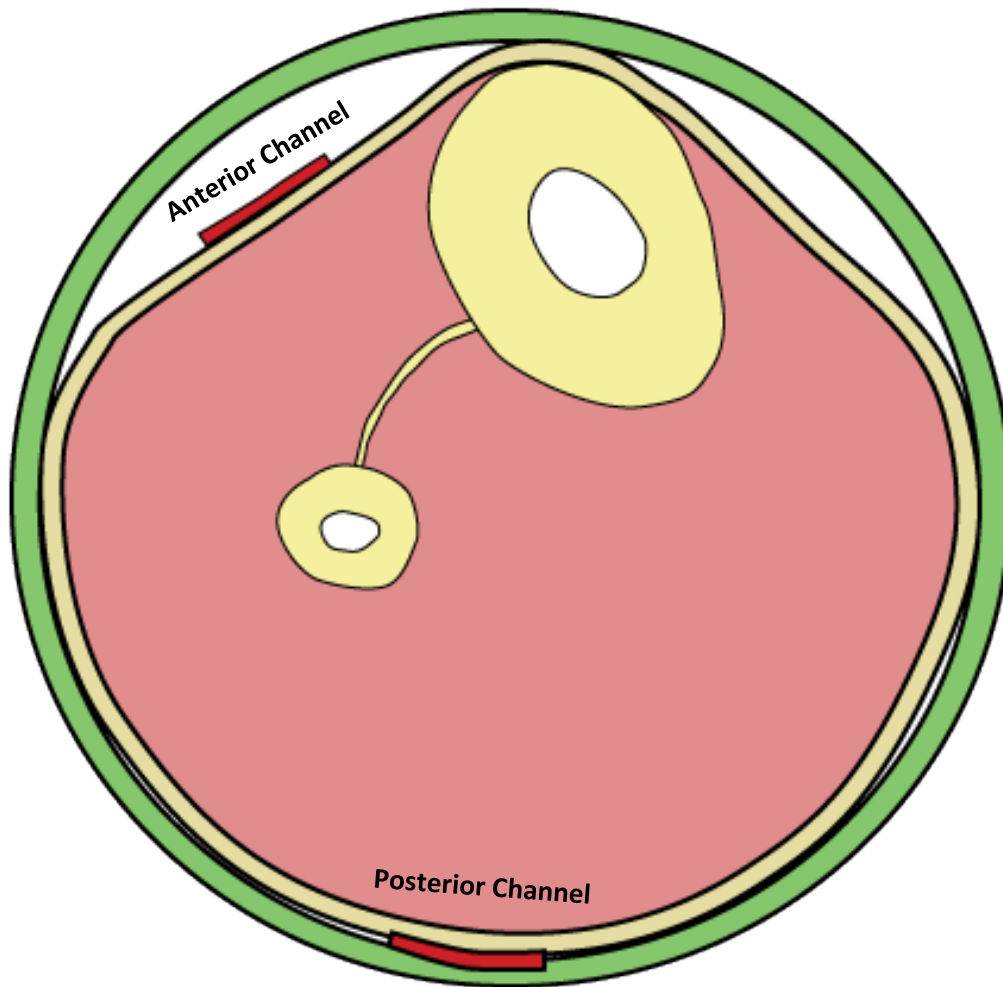

Figure 4.6: An artist's depiction of a residual limb with high tibial prominence. Hammocking is exaggerated in the liner (shown in green) over the antereolateral and antereomedial sections of the limb. Red areas represent sensing electrode placement.

How then is it possible for the anterior and posterior channels to report differing trends in volume change? Grimnes and Martinsen have presented the variable sensitivity of tetrapolar impedance measurements as a potential answer. Not all small volumes of tissue contribute equally to measured impedance. Tissue close to the sensing electrodes will contribute more than volumes deeper or farther away (Martinsen and Grimnes 2008). Therefore, a change in tissue resistivity far from two sensing electrodes will have a smaller effect on transfer impedance than would an equal change in resistivity close to the electrodes (Grimnes, Martinsen, and Johnsen 2010; Grimnes and Martinsen



2006). For this reason, we might expect that electrodes placed antereolaterally would be more sensitive to fluid volume change in the anterior tissue than would electrodes placed on the posterior, while the inverse would be true for the posterior electrodes. Moreover, anterior and posterior sections of the residual limb are naturally divided by anatomical boundaries that inhibit signal conduction across the limb. Examining Figure 4.7, we see that the anterior tibialis muscle makes up the majority of the anterior compartment volume, while the gastrocnemius and soleus muscles comprise most of the posterior. The interosseous membrane, a highly non-conducting structure, connects the fibula and tibia, further decreasing the sensitivity of anterior and posterior channels to fluid volume changes opposite to their electrodes.

The presented theories for differences between anterior and posterior fluid volume measurements remain incomplete. The study was not designed to illuminate differences between sensing channels, and the capabilities of the Indigo device are still being investigated. However, it is clear that any further research into residual limb fluid volume should be designed to thoughtfully consider localized volume changes (anterior vs. posterior, proximal vs. distal, etc.). Additionally, development of a pressure-release socket should account for the effects of applied liner pressures on limb fluid volume change, and should employ the multi-channel capabilities of systems like the Indigo to better examine those differences.

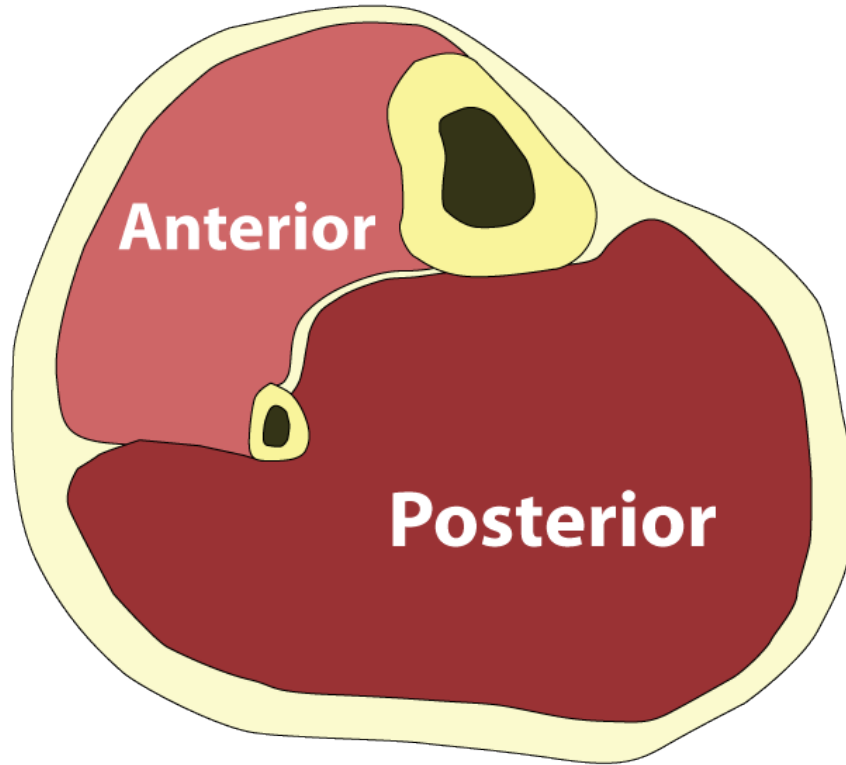

Figure 4.7: Anterior and posterior regions of the transtibial limb are shown. Interosseous membrane between fibula and tibia is clearly shown.

#### 4.4 Parameter Analysis

The measurement of  $R_{ECF}$  and ECF volume requires the assumption of certain parameter values. Equation 4 adapted from Jaffrin et al. is reprinted below. Anthropometric values like C (average circumference at both sensing electrodes) and L (length between sensing electrodes) are determined at the time of data collection and are subject specific. However, the value of  $\rho_{ECF}$  was given to be a static value for each gender: 40.5  $\Omega$ -cm for men and 39.0  $\Omega$ -cm for women (Jaffrin and Morel 2008; Dou et al. 2011).

$$V_{ECF} = \left( \frac{\rho_{ECF} * C}{R_{ECF}} \right)^{2/3} * \frac{L^{5/3}}{(4\pi)^{1/3}} \quad (4)$$

However, it is possible that  $\rho_{ECF}$  values were not consistent between subjects of the same gender and between tests. Cox-Reijven et al. calculated values of  $\rho_{ECF}$  ranging from 23 to 58  $\Omega \cdot \text{cm}$  for both men and women, even demonstrating a slight correlation between  $\rho_{ECF}$  and BMI (Cox-Reijven and Soeters 2000). Data was not reported on the variability of  $\rho_{ECF}$  on a subject-by-subject basis. Ward et al. further calculated that changes in  $\rho_{ECF}$  not accounted for in calculations can directly alter estimations of ECF volumes. Ward further stated that a 10% change in  $\rho_{ECF}$  can cause changes of 4.9% in estimated ECF (Ward, Elia, and Cornish 1998). Scharfetter et al. examined changes in extracellular resistivity due to changes in ionic concentrations during dialysis and found that relative  $\rho_{ECF}$  changes were around 4%, causing an estimated 2% error in ECF measurements (Scharfetter et al. 1997). These variations are significant, considering that even a 0.1% change in residual volume can be considered clinically relevant.

Although most published bioimpedance research assumes a constant  $\rho_{ECF}$  for each gender, it may be advantageous to directly measure  $\rho_{ECF}$  values before each bioimpedance test. Estimation of  $\rho_{ECF}$  requires knowledge of limb fat-free mass, body hydration, and  $R_{ECF}$ . Zhu et al. estimated fat-free mass using MRI cross-sectional images, body hydration through deuterium and sodium bromide dilution, and  $R_{ECF}$  using bioimpedance spectroscopy (Zhu et al. 2006). Same-day measurements of  $\rho_{ECF}$  using MRI and dilution would thus be required to generate relevant values for subsequent bioimpedance testing in the lab.  $\rho_{ECF}$  values could be incorporated in post-processing calculations of ECF to produce a more anatomically correct absolute volume measurement. However, due to time and cost, performing MRI and NaBr dilution may not be feasible each time a subject is tested.

Though changes in extracellular resistivity can have a direct impact on estimated ECF volume,  $\rho_{ECF}$  should have no effect on reported data in this thesis. First and foremost, primary literature assumes  $\rho_{ECF}$  to remain relatively constant over the course of a day (Hanai 1968; Dou et al. 2011). Further, only

values of relative fluid volume change have been reported in this thesis. All volume data have been normalized to baseline measurements of fluid volume. When calculating relative fluid volume change as a ratio of two independent estimations, all constant values (i.e. circumference, length, and  $\rho_{ECF}$ ) drop out of equation 4. The resulting formula is a ratio of two independent  $R_{ECF}$  values raised to the two-thirds power. If we accept that  $\rho_{ECF}$  is constant during the ~1.5 hour testing period, extracellular resistivity will not confound estimations of relative volume change.

## 5 Future Work

This is the first work aimed at understanding the effects of socket pressure release on limb fluid volume. By better understanding the variables and causes involved in fluid volume recovery in the residual limb, it should be possible to design and construct prosthetic sockets capable of decreasing applied pressure on the residual limb at specific times (e.g., when a user sits) or based on specific physiological criteria (e.g., when the residuum has lost fluid volume). The release of pressure in such a manner would likely allow for the recovery of ECF volume similar to the gains seen in the OFF and LINER tests. Volume recovery may thus encourage a healthy fit between the limb and prosthesis. The user may simply release the pressure applied by this socket and regain lost ECF instead of adding a sock to compensate for perceived volume loss. Furthermore, if the socket is designed to release pressure without necessitating full removal of the prosthesis, liner, or of articles of clothing, the prosthetic user would avoid the complications (e.g., removing pants and full doffing of the limb) often encountered with sock addition. However, the specific length of time required to recover a sufficient limb fluid volume is still unknown. If external pressures are released to zero (as during the OFF protocol), a 30 minute recovery may induce a higher-than-optimal volume gain. Further research must be done to decide what length of recovery time is appropriate to induce volume recovery for each individual.

From this study we have an improved understanding of how pressure reduction affects residual limb fluid volume. Subjects who sat for 30 minutes with the prosthesis donned lost limb fluid volume and did not regain volume during subsequent periods of activity. Subjects experienced a fluid volume gain after doffing the prosthesis and liner for 30 minutes. This fluid volume gain persisted during subsequent periods of activity. Subjects who sat for 30 minutes with the prosthesis doffed and the liner donned gained fluid volume but returned to pre-sit volume levels during subsequent activity,

though fluid volume remain elevated when compared to sitting with the socket donned. For socket users who experience a loss in limb fluid volume over the course of the day, it may be advantageous to simply doff the prosthesis during periods of inactivity. We advocate further investigation into pressure-release induced volume recovery as a potential replacement or augmentation to other volume management strategies.

## List of References

- Anon. 2005. *Medicare region C durable medical equipment prosthetics orthotic supplier (DMEPOS) manual*. Columbia (SC).
- Backus, Byron. 2005. "Problems in Lower Limb Socket Fit | American Academy of Orthotists & Prosthetists." *American Academy of Orthotists & Prosthetists* 1 (5).
- Bao, J Z, C C Davis, and R E Schmukler. 1993. "Impedance spectroscopy of human erythrocytes: system calibration and nonlinear modeling." *IEEE transactions on bio-medical engineering* 40 (4) (April): 364-78. doi:10.1109/10.222329.
- Baumgartner, Richard, Cameron Chumlea, and Alex Roche. 1990. "Bioelectric Impedance for Body Composition." *Exercise & Sport Science reviews* 18 (1): 193-224.
- Beil, Tracy L, Glenn M Street, and Steven J Covey. "Interface pressures during ambulation using suction and vacuum-assisted prosthetic sockets." *Journal of rehabilitation research and development* 39 (6): 693-700.
- Board, W J, G M Street, and C Caspers. 2001. "A comparison of trans-tibial amputee suction and vacuum socket conditions." *Prosthetics and orthotics international* 25 (3) (December): 202-9.
- Bolton, M P, L. C. Ward, a Khan, I Campbell, P Nightingale, O Dewit, and M Elia. 1998. "Sources of error in bioimpedance spectroscopy." *Physiological measurement* 19 (2) (May): 235-45.
- Boonhong, Jariya. 2006. "Correlation between volumes and circumferences of residual limb in below knee amputees." *Journal of the Medical Association of Thailand = Chotmai het thangphaet* 89 Suppl 3 (September): S1-4.
- Boonhong, Jariya, and Osiri Manathip. 2004. Validity and reliability of Girth measurement (Circumference measurement) for calculating residual limb volume in below knee amputees.
- Buis, Arjan, Barrie Condon, Dave Brennan, Brendan McHugh, and Donald Hadley. 2006. "Magnetic resonance imaging technology in transtibial socket research: a pilot study." *Journal of rehabilitation research and development* 43 (7): 883-90.
- Chino, N, J R Pearson, J L Cockrell, H A Mikishko, and G H Koepke. 1975. "Negative pressures during swing phase in below-knee prostheses with rubber sleeve suspension." *Archives of physical medicine and rehabilitation* 56 (1) (January): 22-6.
- Cole, K. S. 1940. "Permeability and impermeability of cell membranes for ions." *Cold Spring Harbor Symposia on Quantitative Biology* 8 (0) (January 1): 110-122. doi:10.1101/SQB.1940.008.01.013.
- Cole, K.S., C. Li, and A.F. Bak. 1969. "Electrical analogues for tissues." *Experimental neurology* 24 (3): 459-473.

- Cole, Kenneth Stewart. 1968. *Membranes, Ions, and Impulses: A Chapter of Classical Biophysics*. University of California Press.
- Commean, P K, and K E Smith. 1997. "Lower extremity residual limb slippage within the prosthesis." *Archives of physical medicine and rehabilitation* 78 (5) (May): 476-85.
- Commean, P K, K E Smith, J M Cheverud, and M W Vannier. 1996. "Precision of surface measurements for below-knee residua." *Archives of physical medicine and rehabilitation* 77 (5) (May): 477-86.
- Commean, P K, K E Smith, and M W Vannier. 1996. "Design of a 3-D surface scanner for lower limb prosthetics: a technical note." *Journal of rehabilitation research and development* 33 (3) (July): 267-78.
- Cox-Reijven, P L, and P B Soeters. 2000. "Validation of bio-impedance spectroscopy: effects of degree of obesity and ways of calculating volumes from measured resistance values." *International journal of obesity and related metabolic disorders : journal of the International Association for the Study of Obesity* 24 (3) (March): 271-80.
- Dingwell, Jonathan, Brian Davis, and Dean Frazier. 1996. "Use Of An Instrumented Treadmill For Real-Time Gait Symmetry Evaluation And Feedback In Normal And Below-Knee Amputee Subjects." *Prosthetics & Orthotics International* 20: 101-110.
- Dou, Yanna, Li Liu, Xuyang Cheng, Liyun Cao, and Li Zuo. 2011. "Comparison of bioimpedance methods for estimating total body water and intracellular water changes during hemodialysis." *Nephrology, dialysis, transplantation : official publication of the European Dialysis and Transplant Association - European Renal Association* 26 (10) (October 11): 3319-24. doi:10.1093/ndt/gfq854.
- Fenech, Marianne, and Michel Y Jaffrin. 2004. "Extracellular and intracellular volume variations during postural change measured by segmental and wrist-ankle bioimpedance spectroscopy." *IEEE transactions on bio-medical engineering* 51 (1) (January): 166-75. doi:10.1109/TBME.2003.820338.
- Fernie, G R, P J Holliday, and R J Lobb. 1978. "An instrument for monitoring stump oedema and shrinkage in amputees." *Prosthetics and orthotics international* 2 (2) (August): 69-72.
- Fox, Charles J, David L Gillespie, Sean D O'Donnell, Todd E Rasmussen, James M Goff, Chatt A Johnson, Richard E Galgon, Timur P Sarac, and Norman M Rich. 2005. "Contemporary management of wartime vascular trauma." *Journal of vascular surgery : official publication, the Society for Vascular Surgery [and] International Society for Cardiovascular Surgery, North American Chapter* 41 (4) (April): 638-44. doi:10.1016/j.jvs.2005.01.010.
- Golbranson, F L, R W Wirta, E J Kuncir, R L Lieber, and C Oishi. 1988. "Volume changes occurring in postoperative below-knee residual limbs." *Journal of rehabilitation research and development* 25 (2) (January): 11-8.



- Goswami, J, R Lynn, G Street, and M Harlander. 2003. "Walking in a vacuum-assisted socket shifts the stump fluid balance." *Prosthetics and orthotics international* 27 (2) (August): 107-13.
- Greenwald, RM, and RC Dean. 2003. "Volume management: Smart Variable Geometry Socket (SVGS) technology for lower-limb prostheses." *Journal of Prosthetics and Orthotics* 15 (3): 107-112.
- Grevsten, S. 1978. "Ideas on the suspension of the below-knee prosthesis." *Prosthetics and orthotics international* 2 (1) (April): 3-7.
- Grevsten, S, and U Eriksson. 1974. "Stump-socket contact and skeletal displacement in a suction patellar-tendon bearing prosthesis." *The Journal of bone and joint surgery. American volume* 56 (8) (December): 1692-6.
- Grimnes, Sverre. 2007. "Sources of error in tetrapolar impedance measurements on biomaterials and other ionic conductors." *Journal of Physics D: Applied Physics* 40 (1) (January 7): 9-14. doi:10.1088/0022-3727/40/1/S02.
- Grimnes, Sverre, and Ørjan G Martinsen. 2006. *Bioimpedance & Bioelectricity Basics*. Spectrum. Academic Press.
- Grimnes, Sverre, Ørjan G Martinsen, and Gorm K Johnsen. 2010. "Mutual localization of electrode pairs in a 4-electrode measuring system." *Journal of Physics: Conference Series* 224 (April 1): 012074. doi:10.1088/1742-6596/224/1/012074.
- Hachisuka, Kenji, Koichiro Dozono, Hajime Ogata, Saburo Ohmine, Hideo Shitama, and Koichi Shinkoda. 1998. "Total surface bearing below-knee prosthesis: Advantages, disadvantages, and clinical implications." *Archives of Physical Medicine and Rehabilitation* 79 (7) (July): 783-789. doi:10.1016/S0003-9993(98)90356-2.
- Hanai, T. 1968. Electrical properties of emulsions. In *Emulsion science*, 354-477. London, UK: Academic Press.
- Hanspal, R S, Keren Fisher, and Richard Nieveen. 2003. "Prosthetic socket fit comfort score." *Disability and rehabilitation* 25 (22) (November 18): 1278-80. doi:10.1080/09638280310001603983.
- He, P, K Xue, Q Chen, P Murka, and S Schall. 1996. "A PC-based ultrasonic data acquisition system for computer-aided prosthetic socket design." *IEEE transactions on rehabilitation engineering : a publication of the IEEE Engineering in Medicine and Biology Society* 4 (2) (June): 114-9.
- He, P, K Xue, and P Murka. 1997. "3-D imaging of residual limbs using ultrasound." *Journal of rehabilitation research and development* 34 (3) (July): 269-78.
- Hoffer, E C, C K Meador, and D C Simpson. 1969. "Correlation of whole-body impedance with total body water volume." *Journal of applied physiology* 27 (4) (October): 531-4.

- Jaffrin, Michel Y, and Hélène Morel. 2008. "Body fluid volumes measurements by impedance: A review of bioimpedance spectroscopy (BIS) and bioimpedance analysis (BIA) methods." *Medical engineering & physics* 30 (10) (December): 1257-69. doi:10.1016/j.medengphy.2008.06.009.
- Jenin, P, J Lenoir, C Rouillet, A L Thomasset, and H Ducrot. 1975. "Determination of body fluid compartments by electrical impedance measurements." *Aviation, space, and environmental medicine* 46 (2) (February): 152-5.
- Johansson, S, and T Oberg. 1998. "Accuracy and precision of volumetric determinations using two commercial CAD systems for prosthetics: a technical note." *Journal of rehabilitation research and development* 35 (1) (January): 27-33.
- Klute, Glenn K, Brian C Glaister, and Jocelyn S Berge. 2010. "Prosthetic liners for lower limb amputees: a review of the literature." *Prosthetics and orthotics international* 34 (2) (June): 146-53. doi:10.3109/03093641003645528.
- Kosterich, J D, and K R Foster. 1983. "Dielectric permittivity and electrical conductivity of fluid saturated bone." *IEEE transactions on bio-medical engineering* 30 (2) (February): 81-6.
- Kydd, William L., and Colin H. Daly. 1982. "The biologic and mechanical effects of stress on oral mucosa." *The Journal of Prosthetic Dentistry* 47 (3) (March 1): 317-329. doi:10.1016/0022-3913(82)90162-7.
- Leaf, Alexander. 1970. "Regulation of intracellular fluid volume and disease." *The American Journal of Medicine* 49 (3) (September 1): 291-295. doi:10.1016/S0002-9343(70)80019-5.
- Lilja, M, and T Oberg. 1995. "Volumetric determinations with CAD/CAM in prosthetics and orthotics: errors of measurement." *Journal of rehabilitation research and development* 32 (2) (May): 141-8.
- De Lorenzo, A, A Andreoli, J. Matthie, and P. Withers. 1997. "Predicting body cell mass with bioimpedance by using theoretical methods: a technological review." *Journal of applied physiology* 82 (5) (May): 1542-58.
- Martinsen, Ørjan G, and Sverre Grimnes. 2008. The Concept of Transfer Impedance in Bioimpedance Measurements. In *ECIFMBE Proceedings 22*, 1078-1079.
- Martinsen, Ørjan G, Sverre Grimnes, and Erlend Haug. 1999. "Measuring depth depends on frequency in electrical skin impedance measurements." *Skin Research and Technology* 5 (3) (August): 179-181. doi:10.1111/j.1600-0846.1999.tb00128.x.
- Matthie, J. R., P. O. Withers, M. Van Loan, and Mayclin P. L. 1992. Development of a commercial complex bio-impedance spectroscopic (CBIS) system for determining intracellular water (ICW) and extracellular water (ECW) volumes. In *Proceedings of the 8th International Conference on Electrical Bio-impedance*, 203-205.

- Owings, M F, and L J Kozak. 1998. "Ambulatory and inpatient procedures in the United States, 1996." *Vital and health statistics. Series 13, Data from the National Health Survey* (139) (November): 1-119.
- Pettersen, Fred-Johan, and Jan Olav Høgetveit. 2011. "From 3D tissue data to impedance using Simpleware ScanFE+IP and COMSOL Multiphysics – a tutorial." *Journal of Electrical Bioimpedance* 2 (1) (March 7): 13-32. doi:10.5617/jeb.173.
- Portnoy, S, I Siev-Ner, N Shabshin, A Kristal, Z Yizhar, and A Gefen. 2009. "Patient-specific analyses of deep tissue loads post transtibial amputation in residual limbs of multiple prosthetic users." *Journal of Biomechanics* 42 (16) (December 11): 2686-93. doi:10.1016/j.jbiomech.2009.08.019.
- Sabolich, John, and Giovanni Ortega. 1994. "Sense of Feel for Lower-Limb Amputees: A Phase-One Study." *American Academy of Orthotists & Prosthetists* 6 (2): 36-41.
- Sanders, J. E. 2012. "Comparison of Mica and Traditional Socket Volumes." *Manuscript submitted for Publication*.
- Sanders, J. E., J. C. Cagle, Daniel S Harrison, and Ari Karchin. 2012. "Amputee socks: how does sock ply relate to sock thickness?" *Prosthetics and orthotics international* 36 (1) (March): 77-86. doi:10.1177/0309364611431290.
- Sanders, J. E., and D V Cassisi. 2001. "Mechanical performance of inflatable inserts used in limb prosthetics." *Journal of rehabilitation research and development* 38 (4): 365-74.
- Sanders, J. E., C H Daly, and E M Burgess. 1992. "Interface shear stresses during ambulation with a below-knee prosthetic limb." *Journal of rehabilitation research and development* 29 (4) (January): 1-8.
- Sanders, J. E., and Stefania Fatone. 2011. "Residual limb volume change: Systematic review of measurement and management." *The Journal of Rehabilitation Research and Development* 48 (8) (January): 949. doi:10.1682/JRRD.2010.09.0189.
- Sanders, J. E., D. S. Harrison, J. C. Cagle, T. R. Myers, M. a. Ciol, and K. J. Allyn. 2012. "Post-doffing residual limb fluid volume change in people with trans-tibial amputation." *Prosthetics and Orthotics International* In Press (May 15). doi:10.1177/0309364612444752.
- Sanders, J. E., Daniel S Harrison, K. J. Allyn, and Timothy R. Myers. 2009. "Clinical utility of in-socket residual limb volume change measurement: case study results." *Prosthetics and orthotics international* 33 (4) (December): 378-90. doi:10.3109/03093640903214067.
- Sanders, J. E., Ellen L. Rogers, and Daniel C. Abrahamson. 2007. "Assessment of residual-limb volume change using bioimpedance." *The Journal of Rehabilitation Research and Development* 44 (4): 525. doi:10.1682/JRRD.2006.08.0096.
- Sanders, J. E., Michael Severance, David Swartzendruber, K. J. Allyn, and Marcia Ciol. 2012. "Algorithm for amputee residual limb shape comparison: Sensitivity to weighting of volume

mimization vs. shape similarity." *Transactions on Neural Systems and Rehabilitation Engineering* In Press.

Scharfetter, H, G H Wirnsberger, H Holzer, and H Hutten. 1997. "Influence of ionic shifts during dialysis on volume estimations with multifrequency impedance analysis." *Medical & biological engineering & computing* 35 (2) (March): 96-102.

Schwan, H P. 1957. "Electrical properties of tissue and cell suspensions." *Advances in biological and medical physics* 5 (January 18): 147-209.

Segal, K.R., and S. Burastero. 1991. "Estimation of extracellular and total body water by multiple-frequency bioelectrical-impedance measurement." *The American journal of clinical nutrition* 54 (1): 26.

Silver-Thorn, M B, J W Steege, and D S Childress. 1996. "A review of prosthetic interface stress investigations." *Journal of rehabilitation research and development* 33 (3) (July): 253-66.

Singh, Rajiv, John Hunter, and Alistair Philip. 2007. "Fluid collections in amputee stumps: a common phenomenon." *Archives of physical medicine and rehabilitation* 88 (5) (May): 661-3. doi:10.1016/j.apmr.2007.02.016.

Smith, Douglas G, Lynne V McFarland, Bruce J Sangeorzan, Gayle E Reiber, and Joseph M Czerniecki. 2003. "Postoperative dressing and management strategies for transtibial amputations: a critical review." *Journal of rehabilitation research and development* 40 (3): 213-24.

Sonck, W A, J L Cockrell, and G H Koepke. 1970. "Effect of liner materials on interface pressures in below-knee prostheses." *Archives of physical medicine and rehabilitation* 51 (11) (November): 666-9.

Starr, T W. 1980. "A computerized device for the volumetric analysis of the residual limbs of amputees." *Bulletin of prosthetics research* 10-33 (January): 98-102.

Thirsk, R. B., R. D. Kamm, and A. H. Shapiro. 1980. "Changes in venous blood volume produced by external compression of the lower leg." *Medical & Biological Engineering & Computing* 18 (5) (September): 650-656. doi:10.1007/BF02443139.

Ward, L C, M Elia, and B H Cornish. 1998. "Potential errors in the application of mixture theory to multifrequency bioelectrical impedance analysis." *Physiological measurement* 19 (1) (February): 53-60.

Wotton, MJ, BJ Thomas, BH Cornish, and LC Ward. 2000. "Comparison of Whole Body and Segmental Bioimpedance Methodologies for Estimating Total Body Water." *Annals of the New York Academy of Sciences* 904 (1): 181-186.

Zachariah, S G, Rakesh Saxena, J R Ferguson, and J. E. Sanders. 2004. "Shape and volume change in the transtibial residuum over the short term: Preliminary investigation of six subjects." *The*

*Journal of Rehabilitation Research and Development* 41 (5): 683.  
doi:10.1682/JRRD.2003.10.0153.

Zhu, F, M K Kuhlmann, G a Kaysen, S Sarkar, Charoen Kaitwatcharachai, R Khilnani, L Stevens, et al. 2006. "Segment-specific resistivity improves body fluid volume estimates from bioimpedance spectroscopy in hemodialysis patients." *Journal of applied physiology (Bethesda, Md. : 1985)* 100 (2) (February): 717-24. doi:10.1152/jappphysiol.00669.2005.

Zhu, F, Edward F Leonard, and Nathan W. Levin. 2005. "Body composition modeling in the calf using an equivalent circuit model of multi-frequency bioimpedance analysis." *Physiological measurement* 26 (2) (April): S133-43. doi:10.1088/0967-3334/26/2/013.

Ziegler-Graham, Kathryn, Ellen J MacKenzie, Patti L Ephraim, Thomas G Trivison, and Ron Brookmeyer. 2008. "Estimating the prevalence of limb loss in the United States: 2005 to 2050." *Archives of physical medicine and rehabilitation* 89 (3) (March): 422-9. doi:10.1016/j.apmr.2007.11.005.

